

IceCube

Neutrino Observatory

Maintenance & Operations Plan

February 2011

Revision 1.1

IceCube

MAINTENANCE & OPERATIONS PLAN

February 2011

SUBMITTED BY:

Francis Halzen
IceCube Principal Investigator
University of Wisconsin-Madison

James H. Yeck
IceCube Co-PI and Director of Operations
University of Wisconsin-Madison

Albrecht Karle
Co-PI and Associate Director for Science and Instrumentation
University of Wisconsin-Madison



Revision History

Revision	Date Revised	Section Revised	Action
1.0	01/31/2011		First version
1.1	02/23/2011	1.0	Revise opening statement – IceTop surface array
		2.1	Update the energy range of background atmospheric neutrinos.
		3.1.1	DOMs - Required Capabilities - revise dynamic range.
		3.2.1	USAP Infrastructure – refer to NSF Support Contractor
		4.1	Organization – consistency with the Director of Operations position.
		4.1.1	NSF Organization, update DACS division & AAGS Program names
		4.1.8	Milestones – Data Sharing and Data Management Plan – April 2011
		5.1.2	IceCube M&O Common Fund – refer to the annual PhD. Author fee



Table of Contents

Revision History	i
Table of Contents	ii
List of Acronyms and Terms	v
1. Preface	1
2. Achievement of Scientific Vision	1
2.1. Vision for Scientific Discovery	2
2.2. Five-Year Roadmap	6
3. Technical Approach	6
3.1. Detector Description and Performance	7
3.1.1. Digital Optical Modules (DOMs)	8
3.1.2. IceTop	10
3.1.3. Central Electronics and Data Processing System (Counting House)	10
3.2. IceCube Infrastructure	11
3.2.1. United States Antarctic Program (USAP) Infrastructure	11
3.2.2. IceCube South Pole System (SPS)	12
3.2.3. IceCube UW Infrastructure	12
3.2.3.1. South Pole Test System (SPTS)	12
3.2.3.2. Data Warehouse and Storage Infrastructure	13
3.2.3.3. Core High Performance Computing (HPC)	13
3.2.3.4. Data Center Infrastructure	14
3.2.4. IceCube Collaboration Computing Infrastructure	14
3.3. Overview of Events to Publications	15
3.4. Enhancement	16
3.4.1. DeepCore	16
3.4.2. Optical, Radio and Acoustic Technologies for Cosmogenic Neutrinos Enhanced	16
4. Management Approach	17
4.1. Organization	17
4.1.1. The U.S. National Science Foundation (NSF)	18
4.1.2. International Oversight and Finance Group (IOFG)	19
4.1.3. University of Wisconsin-Madison	20
4.1.4. IceCube Collaboration	21
4.1.5. Key Personnel	22
4.1.6. Advisory Committees	22
4.1.6.1. Science Advisory Committee	22
4.1.6.2. Software & Computing Advisory Panel	22
4.1.7. M&O Coordination Boards and Organizations	22
4.1.7.1. Coordination Committee	22
4.1.7.2. Trigger Filter Transmit (TFT) Board	22



4.1.7.3	Detector Operations Coordination Committee.....	23
4.1.7.4	Analysis Coordination Working Groups.....	23
4.1.8.	Milestones	23
4.1.9.	Reports and Reviews.....	24
4.2.	Maintenance and Operations Plan	25
4.2.1.	Program Management	26
4.2.1.1.	Program Administration	26
4.2.1.2.	Engineering and R&D Support.....	26
4.2.1.3.	USAP Infrastructure Support	26
4.2.1.4.	Education and Outreach (E&O) Coordination	26
4.2.1.5.	Distributed Computing and Labor Reserve	27
4.2.2.	Detector Maintenance and Operations	27
4.2.2.1.	Run Coordination	27
4.2.2.2.	Data Acquisition (DAQ).....	28
4.2.2.3.	Online Filters (Processing and Filtering—PnF)	28
4.2.2.4.	South Pole System (SPS).....	29
4.2.2.5.	South Pole Test System (SPTS)	29
4.2.2.6.	Experiment Control	30
4.2.2.7.	Detector Monitoring	30
4.2.2.8.	Calibration	31
4.2.2.9.	IceTop Operations	31
4.2.2.10.	Supernova Operations	32
4.2.3.	Computing and Data Management.....	32
4.2.3.1.	Core Software Systems.....	32
4.2.3.2.	Data Storage and Transfer	33
4.2.3.3.	Computing Resources.....	34
4.2.3.4.	Data Production Processing.....	34
4.2.3.5.	Simulation Production	35
4.2.4.	Triggering and Filtering	35
4.2.4.1.	Trigger, Filter and Transmission (TFT) Coordination	35
4.2.4.2.	Physics Filters.....	36
4.2.5.	Data Quality, Reconstruction and Simulation Tools.....	36
4.2.5.1.	Simulation Programs	36
4.2.5.2.	Reconstruction and Analysis Tools	36
4.2.5.3.	Data Quality.....	37
4.2.5.4.	Offline Data Processing.....	37
4.2.6.	Physics Analysis Coordination.....	37
4.2.6.1.	Analysis Coordinator	37
4.2.6.2.	Publication Committee	38



5. Cost Overview	39
5.1 Funding Sources.....	39
5.1.1 NSF IceCube M&O Award.....	39
5.1.2 IceCube M&O Common Fund.....	40
5.1.3 Institutional In-Kind Contribution	41
5.2 Computing Infrastructure Upgrade Plan	41
Appendix 1: IceCube M&O Work Breakdown Structure.....	I
Appendix 2: IceCube M&O Memorandum of Understanding Effort and Authors Head Count Summary .	II
Appendix 3: IceCube Collaboration Governance Document.....	III
Appendix 4: IceCube Computing Infrastructure FY2010/2011 Upgrade Plan.....	IV



List of Acronyms and Terms

AAGS	NSF Antarctic Astrophysics and Geospace Sciences program within OPP
ADC	Analog-to-Digital Converter chip
AGN	Active Galactic Nuclei
AMANDA	Antarctic Muon and Neutrino Detection Array
ATWD	Analog Transient Wave Digitizer
Condor	UW—Madison workload management system for compute-intensive jobs
CF	Common Funds
Channel WG	The refined data streams are first sent to Channel Working Groups for initial analysis
DACS	NSF Division of Acquisition and Cooperative Support
DAQ	Data Acquisition System
DOM	Digital Optical Module
DOMCal	DOM Calibration runs system
DOM hub	Surface cable terminus with electronics
DOR	DOM Readout
E&O	Education and Outreach
EMI	Electromagnetic Interference
GLOW	Grid Laboratory of Wisconsin
GZK	Theoretical upper limit on the energy of cosmic rays
GRB	Gamma Ray Burst
GridFTP	An extension of the standard File Transfer Protocol (FTP) for use with Grid computing
HPC	High Performance Computing
ICB	IceCube Collaboration Board– the entity that guides and governs the scientific activities
ICDC	IceCube DeepCore sub-array provides sensitivity to neutrinos at lower energies
IceCube Live	The system that integrates control of all of the detector’s critical subsystems
IceProd	IceCube Simulation production custom-made software
IceSim	IceCube Simulation Software package tools
IceTray	IceCube Core Analysis software framework is part of the IceCube core software library
ICL	IceCube Laboratory (South Pole)
Ingest	Data input application
IOFG	International Oversight and Finance Group
IRC	The IceCube operations organization is located within UW's IceCube Research Center
ITS	IceCube Transport System (ITS)
LC	Local Coincidence
LED	Light emitting diode
LONI	Louisiana Optical Network Initiative - a fast network connection
M&OP	Maintenance & Operations Plan
MC	Monte Carlo
MoU	Memorandum of Understanding between UW-Madison and all collaborating institutions
MPS	NSF Directorate for Mathematical & Physical Sciences
MREFC	Major Research Equipment & Facilities Construction



IceCube Neutrino Observatory Maintenance and Operations Plan



MSPS	Mega Samples Per Second
OPP	NSF Office of Polar Programs
PBS	Portable Batch System—batch processing and resource mgmt. application
PCTS	Prototype Cable Test System
PDF	Probability Density Functions
Physics WG	Physics Working Groups perform high-level analysis and develop specific analysis tools
PMT	Photomultiplier Tube
PNA	NSF Particle and Nuclear Astrophysics program within MPS
PnF	Process and Filtering
QA	Quality Assurance
RAID	Redundant Array of Independent Disks - increased storage functions and reliability
RedHat	Red Hat Enterprise Linux Server is a commercial product. RedHat Network (RHN)
SAC	Science Advisory Committee
SAN	Storage Area Network
SCAP	IceCube Software & Computing Advisory Panel
SIP	Support Information Package
SN	SuperNova
SNEWS	Supernova Early Warning System network
SNI3DAQ	Supernova Data Acquisition
SPADE	South Pole data movement and archiving system
SPS	South Pole System (at the South Pole)
SPTR	IceCube dedicated high-capacity South Pole TDRS Relay system.
SPTS	South Pole Test System (at UW Madison)
TDRS	A Tracking and Data Relay Satellite is type of a satellite that forms part of the TDRSS
TDRSS	The Tracking and Data Relay Satellite System is a network of communications satellites
TFT Board	Trigger Filter and Transmit Board
UPS	Uninterruptible Power Supply
USAP	United States Antarctic Program
UW	University of Wisconsin at Madison is the host institution of the IceCube collaboration
VPN	Secure connectivity through Virtual Private Network
WBS	Work Breakdown Structure
WIMPs	Weakly Interacting Massive dark matter Particles



1. Preface

In December 2010, the IceCube Project completed the construction of the largest particle detector ever built. The instrument records interactions of high-energy neutrinos that travel through the cosmos and stop in the ultra-transparent natural ice that constitutes the detector. IceCube, including the IceTop surface array, detects cosmic neutrinos, solar neutrinos and those neutrinos that originate from the cosmic ray interactions with the Earth's atmosphere, as well as cosmic-ray air showers.

Enabling our scientific vision requires reliable operation of the IceCube Neutrino Observatory facilities and timely transition from event data to quality publications. Our approach to planning IceCube Maintenance & Operations (M&O) and Physics Analysis defines the full range of tasks required to maximize the detector's scientific discovery and educational potential and distributes these tasks among a central M&O organization and the IceCube collaborating institutions.

This Maintenance & Operations Plan (M&OP) describes the management, roles and responsibilities, lines of authority and communications, critical or significant project activities, and performance objectives and milestones. The M&OP identifies the budget allocation of the various funding sources including the direct NSF funding provided through this award and the Common Fund.

Section 2 reviews the scientific vision and objectives that IceCube is designed to achieve and provides a timeline of key milestones. Section 3, Technical Approach, specifies the M&O requirements necessary for IceCube to achieve its design objectives. Section 4, Management Approach, identifies the tasks required to meet the technical requirements and explains how we will perform them. Section 5, Cost Overview, provides a breakdown of costs by funding source.

2. Achievement of Scientific Vision

By operating the partially completed detector the IceCube collaboration has announced the following initial results:

- We have measured the atmospheric neutrino spectrum to an energy of 400 TeV. The highest energy neutrinos observed at accelerator laboratories have energies of less than 1 TeV. Such measurements result in new best limits on violations of Lorentz invariance and Einstein's equivalence principle. They also allow us to revisit the study of neutrino mass in a new energy regime.
- We have established that the arrival directions of the highest energy Galactic cosmic rays are not uniformly distributed in the sky. We have discovered a large excess in the direction of Vela, the strongest gamma ray source in the sky.
- At the highest neutrino energies we have extended the sensitivity of IceCube to the Southern sky.
- We have established the best sensitivity to neutrinos produced by extragalactic cosmic rays interacting with microwave photons, the so-called GZK neutrinos.
- We have reached the sensitivity to confirm or rule out gamma ray bursts as the sources.
- We have established world-best limits on the existence of particle dark matter with spin-dependent interactions with ordinary matter. In the alternative case of dominant spin-independent interactions, direct searches obtain the best limits.

By operating the completed detector we reach, by the best estimates, the sensitivity to reveal the sources of the Galactic and extragalactic cosmic-ray particles.

This section reviews the scientific vision and objectives that IceCube is designed to achieve and discusses three examples of scientific analysis in details.

2.1. Vision for Scientific Discovery

Although IceCube was conceptually designed as a discovery instrument, with time, its main scientific goals have attained a sharper focus and the IceCube concept is as relevant as ever. We know now that the goals are achievable because detector operation with 22 and 40 strings^{1,2}, has demonstrated performance better than anticipated (**Figure 2.1-1**).

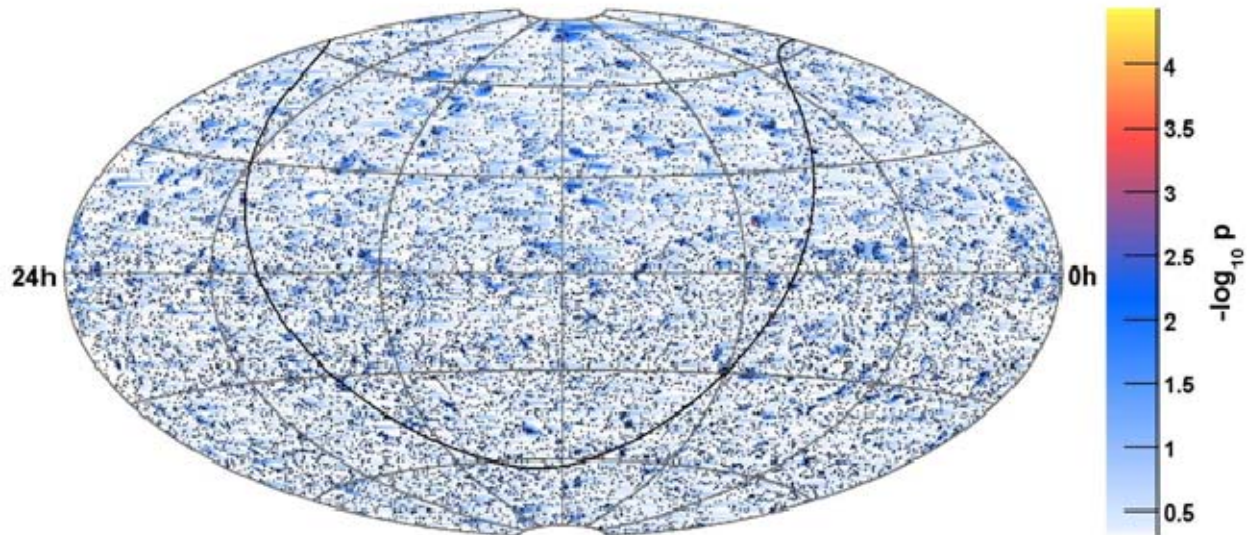

Figure 2.1-1. IceCube Detector Performance. *Using declination and right ascension as coordinates, the map shows the probability for a point source of high-energy neutrinos with energies not readily accommodated by the steeply falling atmospheric-neutrino flux. Their energies range from 100 GeV to several 100 TeV. This map was obtained by operating IceCube with 40 strings for half a year. The “hottest spot” in the map has an excess of 7 events, an excursion from the atmospheric background with a probability of $10^{-4.4}$. After taking into account trial factors, the probability to get a spot this hot somewhere in the sky is not significant. The map contains 6,796 neutrino candidates in the Northern Hemisphere and 10,981 down-going muons rejected to the 10^{-5} level in the Southern Hemisphere, shown as black dots.*

¹ A. Achterberg et al. [IceCube Collaboration], *Astropart. Phys.* 26, 155 (2006), arXiv:astro-ph/0604450; T. Montaruli et al. [IceCube Collaboration], in *Proc. of Topics in Astroparticle and Underground Physics (TAUP07)*, Sendai, Japan, 2007; S. R. Klein [IceCube Collaboration], arXiv:0807.0034 [physics.ins-det].

² J. Dumm [IceCube Collaboration], *Proceedings of the 31st International Cosmic Ray Conference*, Lodz, Poland, 2009.



Astrophysical Neutrinos. A major discovery for IceCube will be the first observation of neutrinos that are expected from cosmological point sources such as gamma-ray bursts and active galactic nuclei (AGN). IceCube has the ability to detect astrophysical neutrinos produced in cosmic sources with an energy density comparable to their energy density in cosmic rays. Supernova remnants satisfy this requirement if they are indeed the sources of the galactic cosmic rays as first proposed by Baade and Zwicky; their proposal is a matter of debate after more than seventy years. Also gamma ray bursts fulfill this prerequisite if they are the sources of the highest energy cosmic rays. In general, the sources of the extragalactic cosmic rays naturally yield similar energy in neutrinos when particles accelerated near black holes, like the central engines of active galaxies or gamma ray bursts, collide with photons in the associated radiation fields³. While the secondary protons may remain trapped in the acceleration region, approximately equal amounts of energy escape as neutrons, secondary neutrinos and electromagnetic radiation. The energy escaping the source is distributed between cosmic rays, and gamma rays and neutrinos produced by the decay of neutral and charged pions, respectively. The IceCube detector has at this point achieved a sensitivity that is at the level of the anticipated neutrino flux from Galactic supernova remnants⁴, and at the level of the neutrino flux associated with gamma ray bursts⁵.

Neutrino Physics. IceCube discoveries in neutrino astronomy have the potential for an improved understanding of the content and evolution of the universe. IceCube looks for cosmic neutrinos through an astronomical foreground of atmospheric neutrinos produced in the Earth's atmosphere. This is a curse and a blessing; the background of neutrinos produced by cosmic rays in interactions with atmospheric nuclei provides a beam essential for calibrating the instrument. It also presents us with an opportunity to do particle physics. The energy range of background atmospheric neutrinos is unique, covering the interval 10 GeV to 10^6 GeV, including energies not within reach of accelerators⁶. Cosmic beams of even higher energy may exist, but the atmospheric beam is guaranteed. IceCube is expected to collect a data set of approximately one half million neutrinos over ten years. The data should address physics topics ranging from the relatively straightforward to the positively exotic. Even in the absence of new physics, just measuring the predicted neutrino cross section at this energy level would be a powerful confirmation of the Standard Model.

Especially interesting in this context is the decrease in threshold to approximately 10 GeV over a significant fraction of IceCube's fiducial volume that will be achieved with the deployment of Deep Core strings⁷. We will accumulate atmospheric neutrino data covering the first oscillation dip at roughly 28 GeV with unprecedented statistics. The equivalent instrumented volume is of order 10 Mton. It has been shown⁸ that the event statistics with five years of data open the possibility to explore the mass hierarchy of neutrinos. The key is to measure the transitions of electron neutrinos into muon and tau neutrinos. A positive result will require a sufficient understanding of the challenging systematics of the measurement; this is under investigation.

³ J.K. Becker, Phys. Rept. 458}, 173 (2008) [arXiv:0710.1557 [astro-ph]].

⁴ F. Halzen, A. Kappes and A. O'Murchadha, Phys. Rev. D78}, 063004 (2008) [arXiv:0803.0314 [astro-ph]]; M.C. Gonzalez-Garcia, F. Halzen and S. Mohapatra, arXiv:0902.1176 [astro-ph.HE].

⁵ The search for muon neutrinos from Northern Hemisphere gamma-ray bursts with the Antarctic Muon and Neutrino Detector Array (AMANDA) (IceCube and IPN collaborations), Astrophysical Journal **674** 1 357-370 (2008); astro-ph/07051186; M. Ackermann et al. [IceCube Collaboration], Astrophys. J. 675 (2008) 1014 [arXiv:0711.3022 [astro-ph]]; IceCube Collaboration (A. Kappes *et al.*), in arXiv:0711.0353 [astro-ph], pages 127-130. □Prepared for 30th International Cosmic Ray Conference (ICRC 2007), Merida, Yucatan, Mexico.

⁶ M. C. Gonzalez-Garcia, F. Halzen and M. Maltoni, Phys. Rev. D 71, 093010 (2005) [arXiv:hep-ph/0502223].

⁷ D.F. Cowen [IceCube Collaboration], Journal of Physics: Conference Series 110, 062005 (2008).

⁸ O. Mena, I. Mocioiu and S. Razzaque, Phys. Rev. D 78, 093003 (2008) [arXiv:0803.3044 [hep-ph]].

Dark Matter Search. IceCube may very well identify the particle nature of dark matter. The detector searches for neutrinos from the annihilation of dark matter particles gravitationally trapped at the center of the Sun and the Earth. In searching for generic weakly interacting massive dark matter particles (WIMPs) with spin-independent interactions with ordinary matter, IceCube is only competitive with direct detection experiments if the WIMP mass is sufficiently large. On the other hand, for spin-dependent interactions, IceCube has already improved on the best limits from direct detection experiments on spin-dependent WIMP cross sections (**Figure 2.1-2**)⁹.

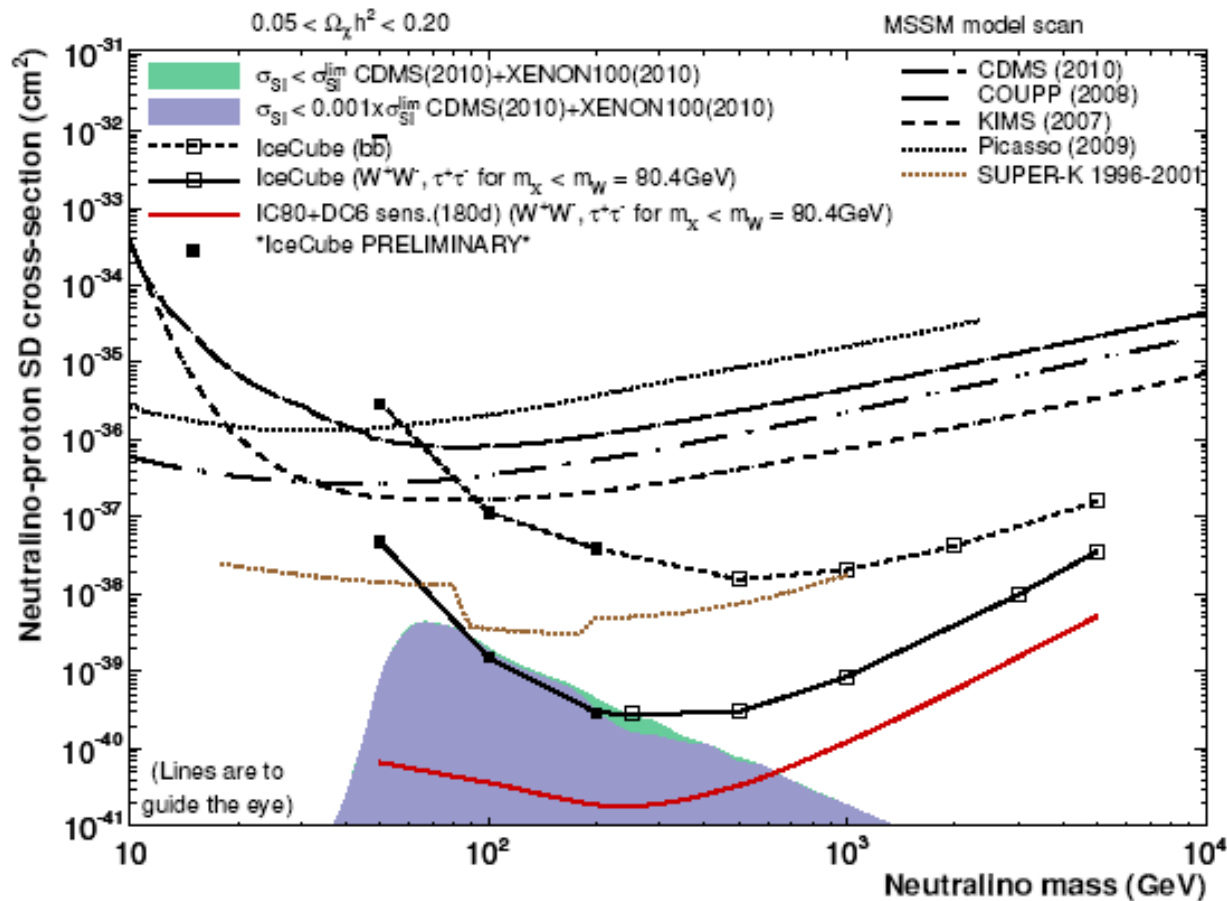

Figure 2.1-2. Dark Matter Search. 90% confidence level limits on the muon flux from neutralino annihilations in the Sun obtained with the 22-string IceCube detector (open squares), compared with previous results of SuperK, Baksan and MACRO and the expected sensitivity of IceCube with six DeepCore strings. The low mass results (black squares) were obtained with AMANDA and are preliminary.

⁹ C. de los Heros [IceCube Collaboration], [arXiv:1012.0184v1[astro-ph.HE]]

Breadth of Discovery Potential. IceCube opens a new window for extragalactic astronomy and astrophysics. By looking for sources of high-energy neutrinos, it has the potential to discover objects and phenomena not accessible to conventional telescopes. IceCube explores a range of neutrino energies not otherwise accessible. It is also a large, three-dimensional cosmic-ray detector, and it is the world’s largest detector of TeV muons. Its capability to observe particles accelerated to TeV scale energies creates the potential for truly high-impact discoveries of unanticipated phenomena. For example, IceCube is using downward muons to study the enigmatic large and small scale anisotropies observed in the cosmic ray muon flux identified by northern detectors (**Figure 2.1-3**). Expanding the measurement to the Southern Hemisphere should help to discover the cause of this unanticipated phenomenon.

Another example worth mentioning is that IceCube is a member of the SNEWS network. The passage of a large flux of MeV-energy neutrinos produced by a galactic supernova over a period of seconds will be detected as an excess of the background counting rate in all individual optical modules. Although only a counting experiment, IceCube will measure the time profile of a neutrino burst near the center of the Galaxy with statistics of about one million events, equivalent to the sensitivity of a 2 megaton detector.

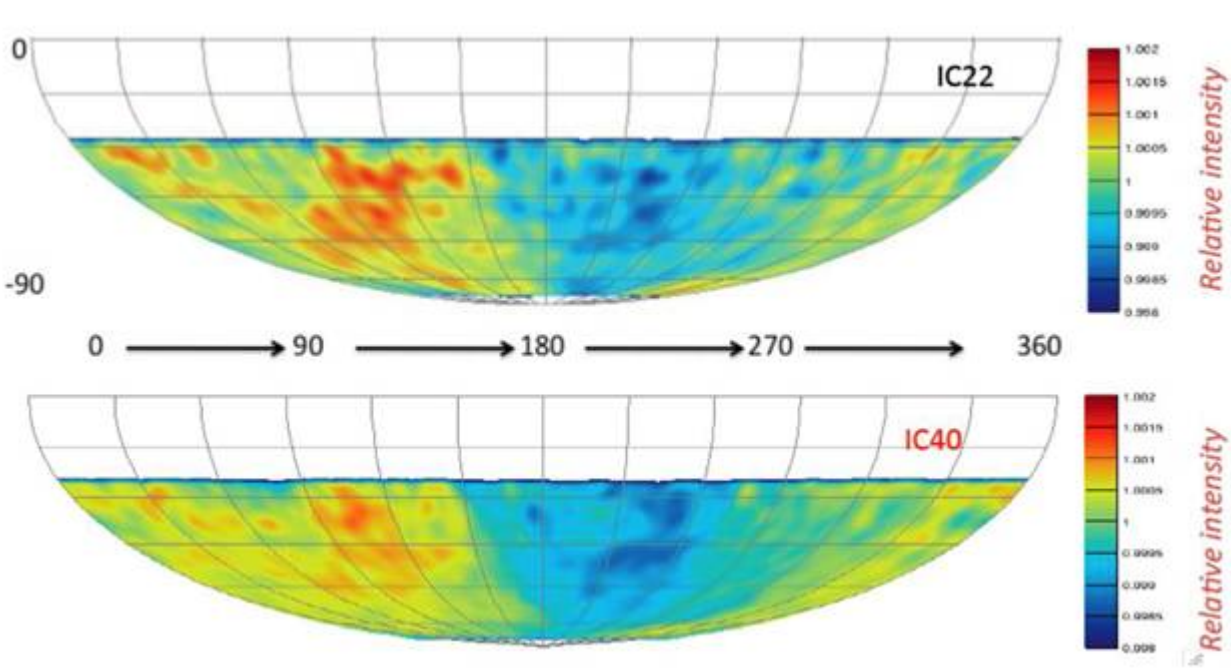

Figure 2.1-3. Relative intensity sky-map. *Sky-map of the relative intensity in arrival direction of cosmic rays for IceCube observation with 22 strings (top), and preliminary sky-map of the relative intensity for IceCube observation with 40 strings (bottom), in equatorial coordinates. A gaussian smoothing has been applied to the map for visualization purposes. Note that since the declination belts in the equatorial map are treated independently, the maps provide only information on the relative modulation of the arrival direction of cosmic rays along the right ascension¹⁰.*

¹⁰ S. Toscano [IceCube Collaboration], Observation of the anisotropy in arrival direction of Cosmic Rays with IceCube, [arXiv:1011.5428v1 [astro-ph.HE]]



2.2 Five-Year Roadmap

The Maintenance & Operation program defined in this plan, combined with research support for each of the IceCube collaborating groups, will ensure the full exploitation of the discovery potential of the observatory from October 1, 2010 through September 30, 2015. The IceCube M&O plan is informed by the experience gained during construction and the initial M&O phase. Over the next five years, IceCube transitions from construction to stable maintenance and operations. Our approach acknowledges three discrete phases—construction, transition, and stable M&O—and harnesses the talents and resources of the entire IceCube collaboration. As we move into stable operations we will maximize IceCube’s scientific and educational value by fully engaging the capabilities of our collaborators in both physics analysis and M&O activities. We anticipate that the collaboration will continue to grow, expanding both the scope of physics analysis and M&O activities and the opportunities for additional contributions.

Stable facility operations and timely data analysis are possible through a combination of the central NSF M&O support and direct support by funding agencies to collaborating groups. The five-year roadmap is based on a forecast of data rates, volumes, processing, and access requirements that are derived from both the initial operations experience and a projection of the requirements of the final detector. The final configuration of the IceCube facility consists of 5,160 Digital Optical Modules (DOMs) installed on 86 strings and 324 DOMs installed in 162 surface tanks.

The facility operations and data preparation require strong technical coordination between the Collaboration and UW-Madison as described in Section 4.

The substantial investment made by the NSF and its partner funding agencies in constructing the IceCube facilities, a \$279 million expenditure, produced not only a detector that meets or exceeds original performance goals, but data management and computing facilities that provide for continuous data collection, data production, and data processing.

The first milestone in the transition of the facility from construction, primarily supported by the NSF Major Research Equipment and Facilities Construction (MREFC) program, to M&O was in 2007 with issuance of a three-year Cooperative Agreement between NSF and the University of Wisconsin for IceCube M&O. The IceCube International Oversight and Finance Group (IOFG), a group composed of NSF and representatives of German, Swedish, and Belgian funding agencies, endorsed the original M&O program, agreeing to support initial operations and research to ensure the early exploitation of the construction investment. The transition phase started on April 1, 2007 and extended through Sept. 2010.

3. Technical Approach

IceCube as a discovery instrument with multiple scientific objectives requires many varied search strategies. It will look for steady point sources of muon neutrinos in the northern sky—for example, active galactic nuclei or supernova remnants. Other searches target transient point sources such as gamma-ray bursts or supernovae in progress. Yet another search strategy is to look for an extraterrestrial neutrino flux coming from the entire sky or from a large part of it—for example, the Milky Way. To achieve these multiple objectives, IceCube must be properly calibrated and continuously monitored to ensure high quality data. It also requires computing and facilities infrastructure, and the corresponding maintenance and updates necessary to achieve high standards of reliability and quality.

This section sets the technical M&O requirements and specifications ensuring IceCube reliably and continuously provides the capability to achieve its scientific objectives.



3.1. Detector Description and Performance

Required Capabilities. IceCube is designed to detect muons and cascades over a wide energy range. The string spacing was chosen in order to reliably detect and reconstruct muons with energies over 1 TeV and to precisely calibrate the detector using flashing LEDs and atmospheric muons. Because of the attenuation and scattering of light, a certain density of sensors is required to be sure to obtain many measurements along each track, which is important for pointing accuracy, background rejection, and energy measurement. The optical properties of the South Pole ice have been measured with various calibration devices and are used for modeling the detector response to charged particles. Muon reconstruction algorithms allow measuring the direction and energy of tracks that come from all directions.

The depth requirement was driven by two constraints: a) go below the region where air bubbles contribute to light scattering (1400 m), and b) maximize the use of the remaining depth without risking too close an approach to bedrock (2800 m). Exploratory measurements with the Antarctic Muon And Neutrino Detector Array II (AMANDA-II) verified that the ice would be clearer in the region below 2100 m. The greater clarity helps with reconstruction and the greater depth minimizes background effects.

Some of the high level design goals include:

- Angular resolution for muons (E^{-2} spectrum): $<1^\circ$
- Angular resolution for muons at 1000 TeV: $<0.7^\circ$
- Muon Effective area at 10 TeV: 0.9km^2 (Expected: $>0.9\text{km}^2$)
- Livetime: $>95\%$ (Expected: $>97\%$)

Infrastructure. The final configuration of the detector, (**Figure 3.1-1**), consists of 86 strings with an instrumented depth range from 1450 m to 2450 m below the surface. There are 60 optical sensors mounted on each string, with equal spacing for standard strings. On the eight strings of the Deep Core, 50 sensors are deployed at a smaller spacing of 7 m between 2100 m and 2450 m with 10 sensors above 1950 m for additional veto functions. In addition there are 324 sensors deployed in 162 IceTop detector tanks on the surface of the ice directly above the strings. The sensors are connected to the IceCube Lab (ICL) with a cable containing copper wires, one twisted pair for each pair of sensors. The ICL supports all data processing infrastructures to build events and process the data.

M&O Requirements. All subsystems in the IceCube infrastructure require effort to maintain and operate. Even though some hardware systems are frozen into the ice, the overall system will undergo changes in time. Calibration constants change over time, data rates change due to the change of the atmosphere, and sensors may display defects and need quick attention to avoid serious system-wide problems. The major effort is required for maintenance and operation of the complex computer systems in the ICL and for data management.

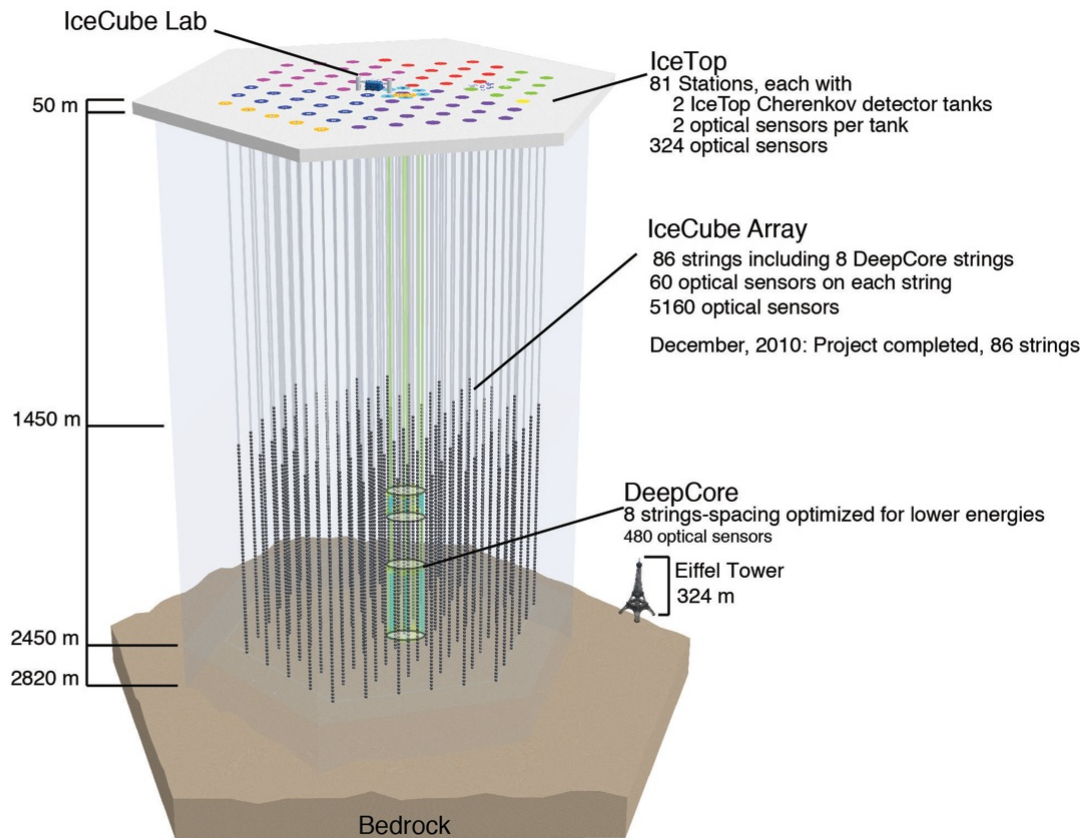

Figure 3.1-1. Schematic View of IceCube Detector. *The detector must be calibrated and continuously monitored to ensure collection of high-quality scientific data.*

3.1.1. Digital Optical Modules (DOMs)

Required Capabilities. Each sensor is required to detect the Cherenkov light emitted by the charged particles with high sensitivity and a time resolution of a few nanoseconds and high dynamic range. Requirements include:

- Time resolution: 5 nsec (Actual: ~3 nsec)
- Time synchronization to Masterclock: <3 nsec (Actual: 1.5 nsec)
- Noise rate (with deadtime): 500 Hz (Actual: ~350 Hz)
- Linear dynamic range: 200PE/15 nsec (Actual: ~500 PE/15 ns)
- Failure rate (permanent failures): <5%/15yr (Forecast: <2.5%/15yr)
- Deadtime within run: <1% (Actual: < 0.01%)

For IceCube, timing precision at the level of a few nsec is necessary to maximize the accuracy of angular reconstruction; when looking for point sources of neutrinos in the sky, having two tracks pointing to the same spot within 0.5 degrees is more significant than having them point to the same spot within 1 degree, because random background tracks are four times more likely to occur within 1 degree.

The dynamic range of 200 photoelectrons per 15 nsec is relevant in IceCube DOMs in order to measure light near high energy tracks, which is directly proportional to their energy (loss). For extremely high energies, the light will saturate nearby DOMs, and the energy must be determined with more distant DOMs, requiring a precise simulation of the photon propagation over large distances.

For IceTop DOMs, the dynamic range is important because cosmic ray air showers are studied across a wide energy spectrum (about four orders of magnitude), and the signals grow with shower energy.

The noise rate affects the trigger rate, the bandwidth, and most importantly the reconstruction quality and the sensitivity to neutrino bursts from the core collapse of supernovae. Aside from the goal of a low noise rate, it is equally important that the noise is predictable, stable and free of spikes.

Infrastructure—the As-built DOM. Each sensor consists of a 25 cm photomultiplier tube (PMT), connected to a waveform recording data acquisition circuit capable of resolving pulses with nanosecond precision and performing within the requirements as listed above.

Each DOM (**Figure 3.1-2**) triggers autonomously on single photons and sends time-stamped, packetized hit data to the surface. A 33 cm diameter pressurized glass sphere holds the Hamamatsu R7081-02 photomultiplier tube plus associated electronics. These electronics include a high voltage generator, a resistive divider PMT base, a flasher board (containing 12 light emitting diodes, with programmable drivers), and a “Main Board” containing a complete data acquisition (DAQ) system. The DAQ includes two separate waveform digitizer systems. The first is the analog transient waveform digitizer (ATWD), which uses a custom switched-capacitor array chip to collect 128 samples of the PMT output at 300 megasamples per second (MSPS). The ATWD has three independent channels for each PMT providing 16 bits of dynamic range. The second digitizer system uses a commercial 40 MSPS 10-bit ADC chip to record 6.4 μ sec of data after each trigger.

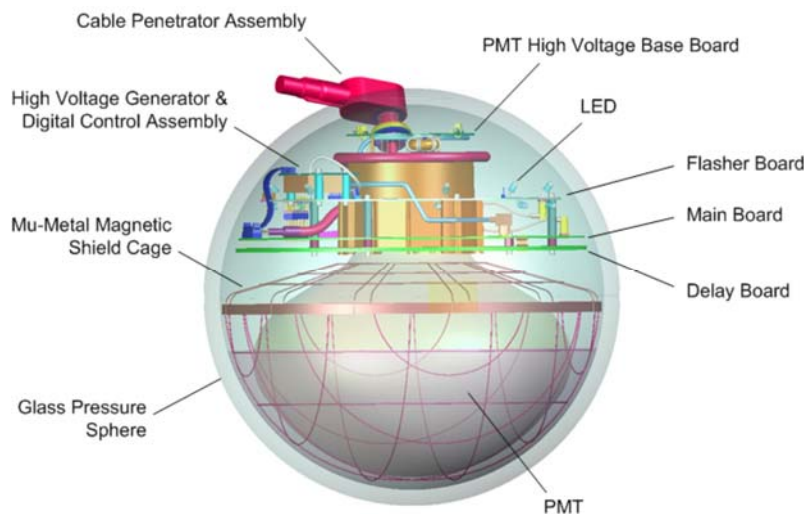

Figure 3.1-2. Digital Optical Module. *As the heart of the detector, DOMs require regular monitoring to detect performance issues that affect the quality of physics data.*

M&O Requirements. The system parameters, such as gains of all amplifiers, noise rates, time resolution, master clock synchronization, photodetection efficiency, and trigger thresholds need to be monitored from run to run, and even in shorter time intervals. Due to the large number of sensors, even occasional perturbations of individual sensors can have detrimental effects on the data quality. While overall a high reliability and stability has been achieved, experience shows that regular monitoring and a rigorous assessment of the observed and often complex issues is required to ensure high data quality. Detailed calibration programs need to be performed on all sensors in regular time intervals. Higher level tests with LED flashers and downward-going cosmic ray muons are used to verify the system time stability between neighboring DOMs and monitor the DOM charge response.



3.1.2 IceTop

Required Capabilities. The IceTop surface detector array is designed to detect cosmic ray airshowers in the energy range from 500 TeV to energies well beyond 1 EeV. A full trigger efficiency is required above 1 PeV for events with the core in the array. Coincidences with the In-Ice detector string array, the main detector of IceCube, allow performance of 3 tasks: a) cosmic ray physics over a wide energy range b) special cross calibrations, and c) certain veto functions. The ice in the tanks must be clear and remain clear without cracks over many years. The stations are exposed to and must survive annual temperature cycles down to below -50°C .

Infrastructure—the As-built IceTop Detector. The surface air shower array, IceTop, consists of ice Cherenkov detector tanks each containing two DOMs, which are operated at different gains for increased dynamic range. Two such tanks are associated with each string. The tanks are embedded in the snow just below the surface to minimize drifting of snow. IceTop detects and measures the position and direction of cosmic ray air showers, which also contain muons that penetrate to IceCube depth.

M&O Requirements. The DOMs used in the IceTop tanks must be serviced like all other DOMs. However, the lower gain of every other sensor and the different noise condition from cosmic rays result in different observables and make the IceTop array a complete detector system on its own. Special expertise is needed to service the IceTop array, both at the DOM level as well as at the DAQ level. The increase of the snow layer on top of the tanks requires annual measurement of the depth of snow on all tanks and then updating this information in the database for reconstruction and simulation.

Comparing the IceCube (In-Ice) measurement of these muons with the IceTop system is one important test of proper calibration and of the reconstruction software. This will be an ongoing comparison through the life of IceCube to make sure that everything continues to function as designed, i.e., calibrations or reconstructions or their interfaces have not become corrupted.

3.1.3 Central Electronics and Data Processing System (Counting House)

Required Capabilities. The array of DOMs in the deep ice and in IceTop needs to be supplied with power, communication and control functions. All sensors are connected to the central data acquisition electronics by cables. A pair of DOMs shares one twisted pair of copper wires. The data are collected in the ICL, located at the geometric center of the IceTop array. Data include full waveforms for all hits in time coincidence between two neighboring DOMs, plus summaries of isolated hits. The data streams from the sensors arrive asynchronously via a digital communications protocol. In the ICL, higher multiplicity coincidences are formed to trigger on muons or cascades in the deep ice, or air showers observed in IceTop. The bandwidth allocation depends on the satellite bandwidth availability at the South Pole. It is a system requirement to store data locally in case of an extended failure of the satellite transmission system.

Infrastructure—Data Acquisition and Data Processing System. An overview of the system architecture is given in **Figure 3.1-3**. Each string (5 cm diameter and typically 3 km long cable) is connected to one stringHub, a computer with special boards that perform the three low level functions listed below. The central data acquisition performs 3 functions:

- Receive data streams from DOMs, perform format changes, form event triggers and build events
- Provide power and slow control functions to DOMs
- Perform synchronization of all DOM clocks with the system masterclock.

M&O Requirements. While the system is designed to perform most functions automatically, the maintenance and operation require professional staff to ensure long term reliability and stable operation of the experiment.

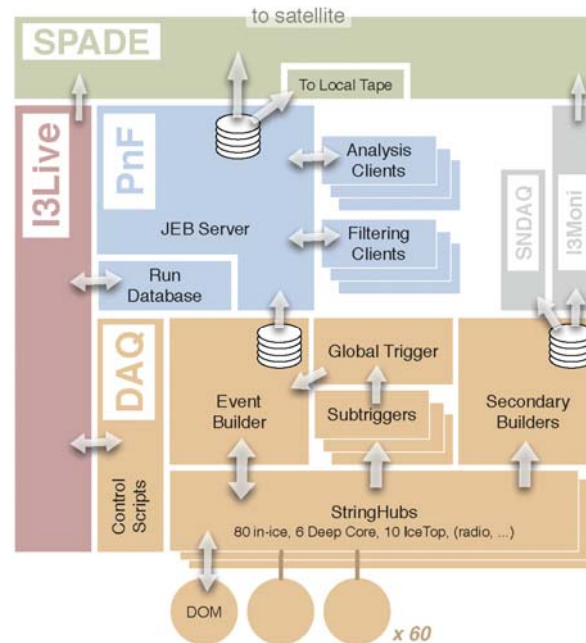

Figure 3.1-3. Detector Data System Architecture. *The data system controls the detector and collects, processes, transmits and stores IceCube and IceTop scientific data.*

3.2. IceCube Infrastructure

3.2.1. United States Antarctic Program (USAP) Infrastructure

Required Capabilities. The IceCube Laboratory (ICL) is one of the core facilities that make up the IceCube Observatory at the South Pole. It fulfills the requirement for a centralized computing facility that also is the physical interface between the IceCube surface cables and the DOM hubs and associated data processing equipment. Additional infrastructure that is required for IceCube maintenance and operations functions are the South Pole Station and the cargo and logistics capability provided by the NSF support contractor. IceCube also requires network access to the South Pole and within the South Pole Station network for data transfer and communications for network access, email, and other basic services. In addition, IceCube needs the capability of transferring data from the South Pole to the IceCube Data Warehouse in Wisconsin in a number of different ways depending on the priority of the data.

Infrastructure. The IceCube computing systems located in the ICL (**Figure 3.2-1**) produce in excess of 30 kW of waste heat which must be removed from the Data Center. To reduce energy consumption of the Data Center the cold external air is used for cooling through an air mixing and handling system. Due to the very high density of equipment in the ICL a failure of the cooling system can result in damaging temperatures within 30 minutes. A high level of reliability and monitoring of the cooling system is therefore required. The NSF support contractor is responsible for the operations, maintenance, monitoring, and response to incidents of the cooling system. The communications infrastructure in the form of satellite connections and physical backbone at South Pole are also maintained by the NSF support contractor.

M&O Requirements. The basic framework of frequent communication (weekly conference calls), one-on-one contacts (NSF support contractor program manager, NSF program officer), Support Information Package (SIP) development, and ad hoc meetings will ensure that the USAP program will continue to provide IceCube with needed USAP infrastructure.



Figure 3.2-1. IceCube Laboratory (ICL). *The ICL at the South Pole houses the online computing system which is critical to mining data from IceCube.*

3.2.2. IceCube South Pole System (SPS)

Required Capabilities. IceCube requires a surface computing system capable of collecting random and asynchronous events that are subsequently merged or processed into standard payloads representing physics data. The hardware and processing needed to accomplish that must scale to meet the real-time constraints associated with sampling 5484 sensors (86 strings and 162 IceTop tanks). Near-line storage and archive systems must be able to handle the subsequent Level 0 data volume generated from the fullscale IceCube detector. IceCube will require adequate margins and stability to reliably power the South Pole System (SPS) for the many operational seasons that follow detector construction.

Infrastructure. Operationally, in its final configuration, the SPS is capable of supporting 86 in-ice strings, and 81 IceTop stations. The SPS is comprised of various hardware and software subsystems.

M&O Requirements. The SPS requires periodic hardware and software maintenance to guarantee reliable operation and maximum detector uptime. System administrators in conjunction with on-site Winterover operators monitor the health of the various subsystems to quickly diagnose and respond to data run failures, misconfigurations, and assorted anomalies. Customized solutions are provided and best practices followed to maintain the data system complement in a stable, quiescent state.

3.2.3. IceCube UW Infrastructure

3.2.3.1. South Pole Test System (SPTS)

Required Capabilities. IceCube requires an independent test system capable of replicating basic functional and performance characteristics of the operational SPS surface computing complement. The South Pole Test System (SPTS) located on the campus of the University of Wisconsin—Madison at Chamberlin Hall continues to provide an environment to build and verify software subsystems prior to deployment on the operational system at the South Pole. To that end, the SPTS will continue to be a mission-critical tool that is utilized to minimize detector downtime. As the SPS experiences upgrades, the SPTS must follow suit to maintain close hardware and operating system proximity.



Infrastructure. The SPTS is a scaled down version of the operational SPS. All major subsystems are represented with some at quantity levels below the operational system. The Processing and Filter function (PnF) and Calibration and Verification subsystem are substantially smaller than that deployed operationally. System infrastructure is similar to that deployed on the operational system including matching power and networking devices. Additional subsystems of the SPTS are maintained to perform specific test functions and simulate entire strings in the lab.

M&O Requirements. The SPTS requires periodic hardware and software maintenance to guarantee reliable operation and maximum system uptime. System administrators manage the test system in a similar fashion to the operational system responding to software developers and other engineering concerns with customized solutions following standard best practices. The various subsystems are monitored to analyze and respond to misconfigurations and other assorted anomalies. DAQ expertise is required to perform the required tests on the lower level test systems.

3.2.3.2. Data Warehouse and Storage Infrastructure

Required Capabilities. IceCube requires a Data Warehouse consisting of software to facilitate the transfer of data from the South Pole and archiving of this data, software for the orderly input of data into the Data Warehouse, standards for organizing the data, such as directory structure and metadata, and hardware for storage of the data.

Infrastructure. The Data Warehouse consists of online storage organized in a storage area network (SAN) architecture. Data is stored in 3 categories: simulation data, experimental data, and analysis data. Supplementing the SAN storage is an HSM system (tape-based file-system) that can be expanded in the future. A backup system provides nightly backups of priority data and creates backup tapes for off-site storage.

There are 2 main software applications involved in the flow of data from the SPS to the Data Warehouse. In the SPS, an application called SPADE ensures the orderly delivery of data from the SPS via 3 mechanisms based on priority and limited by bandwidth. At the Data Warehouse an application called Ingest insures data is entered into the Data Warehouse in an orderly fashion and all data catalogued and accounted for. There is additional software for data access and monitoring of data flow from the SPS.

M&O Requirements. The complete IceCube data set will grow as data is collected, simulated, and analyzed. The final phase of the data life cycle will be long-term storage on the tape-based file system. Growth in data processing, simulation, and analysis requirements will require expansion of SAN storage. Expansion of SAN storage will require corresponding expansion of backup systems for error and disaster recovery. While the software systems in place for the Data Warehouse are mature, as requirements for data transfer, access, monitoring, and control change the software will need to be upgraded and also maintained for system changes. Data standards will also evolve with changing requirements of the experiment.

3.2.3.3. Core High Performance Computing (HPC)

Required Capabilities. IceCube requires a core HPC cluster to perform real time offline analysis of data from the South Pole and for production of key simulation data sets.

Infrastructure. The much larger distributed resources of the collaboration and local resources at UW Madison, such as the GLOW system, supplement the IceCube HPC cluster. The system is closely coupled to the Data Warehouse storage for high throughput computing.

M&O Requirements. As the final strings were added, analysis requirements expanded, simulation requirements increased and additional HPC resources were required. Many requirements will be met using distributed resources, and this work will require close coupling to the Data Warehouse to provide high throughput. Technological advances will also require replacement of hardware in the longer term. Additional clusters commensurate with the existing system will be required on a 2 to 3 year cycle. In addition to hardware, the support of batching software, such as PBS and Condor, an interface such as Grid tools is required.



3.2.3.4. Data Center Infrastructure

Required Capabilities. The Data Center infrastructure is the glue that connects the major computing resources of IceCube (components such as the HPC, Data Warehouse) and controls, and allows access to resources. Core systems include essential services such as distributed authentication, web services, and email systems.

Infrastructure. The current IceCube Data Center is located at the IceCube Research Center in Madison, Wisconsin. Additional infrastructure is allocated for IceCube at the UW Physics Department with associated rackspace.

M&O Requirements. Network services will require continual operational maintenance, while hardware will need to be replaced on a periodic cycle, and services such as HVAC and power will need maintenance and service contracts.

3.2.4. IceCube Collaboration Computing Infrastructure

Required Capabilities. The analysis of experimental data requires a suitable amount of Monte Carlo simulation data that reproduces the detector response to a well-defined set of physics events. The IceCube Observatory event rate is overwhelmingly dominated by cosmic ray induced background events that must be eliminated through a complex event selection process. A large amount of Monte Carlo data needs to be generated in order to perform high quality physics analyses. Weighting techniques allow producing relatively more livetime at higher energies and reduce the total number of required computing servers. According to current estimates the need for sufficient computing resources at the level of several thousand cores will be mandatory to complete physics analyses and publish results. In practice there is often a burst need to run a simulation in an updated configuration.

Infrastructure. The current distributed computing infrastructure consists of contributions from Collaboration institutions in the U.S. and Europe (Germany, Sweden and Belgium). We also have access to the Louisiana Optical Network Initiative (LONI), a fast network connection among universities and research institutions in the State of Louisiana. The main storage facility is the Data Warehouse located at UW-Madison, but other farms provide disks for temporary data storage, even if they are primarily intended for physics analyses. All the final data are transferred to UW-Madison through GridFTP and portions can be stored locally at the institutions that produced them. Existing distributed computing resources are sufficient to allow background simulation of the current detector configuration and for current analysis goals. Access to additional guaranteed HPC resources will be needed in the future to provide sufficient statistics of simulation data.

The effective use of the distributed computing infrastructure is based on a custom-made software package tool called IceProd to manage simulations. IceProd allows for coordinating multiple sites, which share a single centralized database in order to distribute the workload across multiple disconnected clusters and grids.

M&O Requirements. The maintenance of the core and distributed computing infrastructure is essential for a stable and efficient simulation production. The computing farms throughout the Collaboration are managed as contributions by the individual institutions. The storage hardware, mainly located in the UW data center, but also distributed across the production sites (mainly for temporary storage), needs maintenance and replacement on a periodic cycle to insure proper functionality and efficiency.

3.3. Overview of Events to Publications

Reconstructing neutrino events with energies from 100 GeV to 100 PeV, the energy range in which we are most likely to observe cosmic neutrinos, requires precise recording of everything from single photons up to large pulses lasting several microseconds. Proper maintenance and operation of the detector and its supporting infrastructure (Sections 3.1 and 3.2) allow for capture of the targeted events, analysis of the data, and publication of results that contribute to science and education (**Figure 3.3-1**).

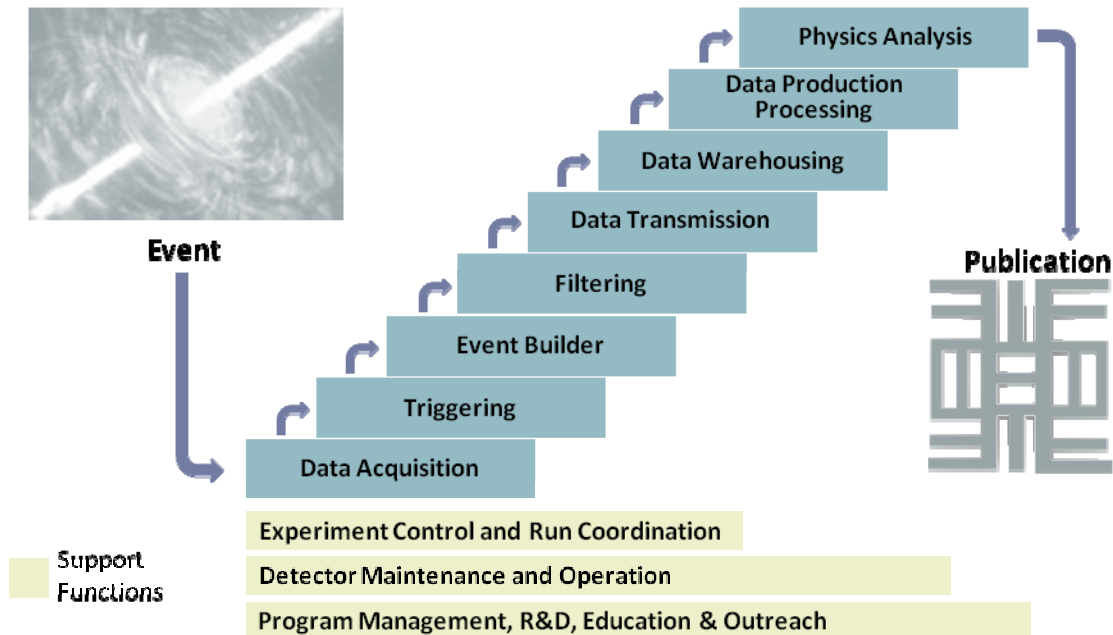

Figure 3.3-1. IceCube Path to Discovery. *Our approach to IceCube M&O is structured to support all tasks required to produce science—from event to publication.*

Detector M&O and Computing and Data Management provide the framework for the collection of targeted data. A key element is DOM calibration, which is performed with a special program at regular time intervals. Whenever the detector is live, it is acquiring data by recording light pulses (hits) on a string and sorting these hits in time. A Run Coordinator oversees and controls the experiment through a global experiment control system called IceCube Live to focus data collection on areas of scientific interest prioritized by the IceCube Collaboration. This requires data filtering that results in more than 10 data streams selected by special filter requests. Examples include upgoing muons, extremely high energy events, gamma ray burst stream, moon (for shadow of the moon), cascade like events, cosmic ray events, ultra low energy events, and WIMPs. These filters are designed by working groups in the Collaboration and are reviewed by the Trigger Filter and Transmit (TFT) Board.

Once a trigger is issued, hits close to the trigger times are collected by event builder processes. Preliminary event reconstruction is performed in the Processing and Filtering farm (PnF) which also reduces the data volume into a size small enough to be transmitted by satellite to the data center in the North. A separate process (SPADE) takes care of managing the data streams, buffering data, sending the PnF stream to the satellite and writing the bulk of the data on tape.

Each data stream is reprocessed after transmission to the Northern Hemisphere data center, where more computing power is available and more sophisticated reconstruction algorithms can be applied. The refined data streams are first sent to channel working groups for initial analysis, then to the physics working groups for high-level analysis and development of specific tools needed to execute the analyses. The Analysis Coordinator manages the analysis process and the Publication Committee manages the publication review processes.

3.4. Enhancement

IceCube’s Deep Core sub-array will lower IceCube’s energy threshold by about an order of magnitude. We are also exploring other technologies of radio and acoustic detection of the highest energy cosmogenic (GZK) neutrino flux [Berezinsky & Zatsepin, 1970; Stecker, 1973]. We will seek or have sought funding for these enhancements in separate awards.

3.4.1. DeepCore

Enhanced Capabilities. The IceCube DeepCore (ICDC) sub-array (**Figure 3.4-1**) is replacing the original AMANDA detector and providing IceCube with sensitivity to neutrinos at energies over an order of magnitude lower than originally envisioned. Consisting of eight strings that were designed especially for this purpose and of seven neighboring standard IceCube strings, the sub-array will dramatically improve on AMANDA’s capabilities through a combination of increased module density, higher quantum efficiency photomultiplier tubes (PMTs), deployment in the clearest ice at depths below 2100 m, and the use of the surrounding standard IceCube modules above and around ICDC as a powerful active veto against the copious downward-going cosmic-ray muon background. IceCube DeepCore will provide enhanced sensitivity to solar WIMP annihilations, extending IceCube’s reach to the experimentally and theoretically most interesting WIMP mass range below 100 GeV. It will give improved acceptance for low energy atmospheric neutrinos at $E_\nu \sim 10$ GeV, opening a useful new window for atmospheric neutrino oscillation measurements, including ν_μ disappearance, ν_τ appearance and possibly the sign of the neutrino hierarchy. Taking advantage of the active vetoing capability provided by the surrounding IceCube array, ICDC will also be able to explore the southern sky for possible neutrino sources such as AGN, GRBs, and the Galactic Center.

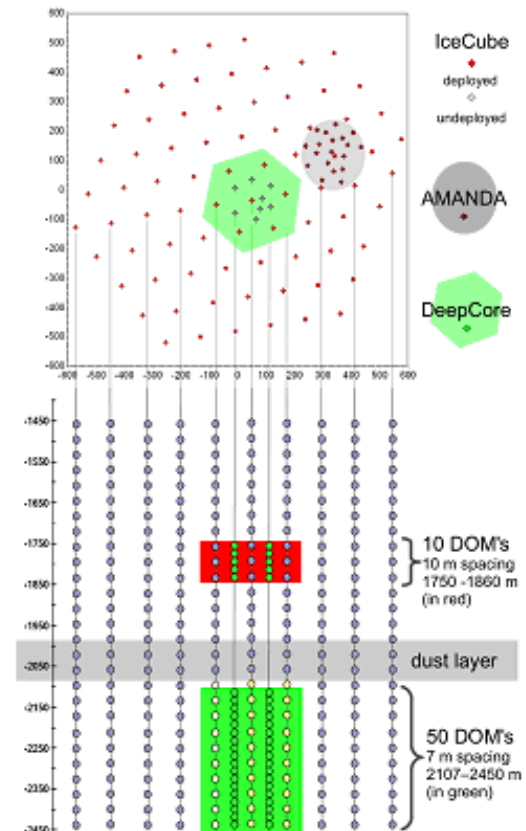

Figure 3.4-1. Deep Core Sub-array.

Infrastructure Requirements. IceCube DeepCore is using high quantum efficiency PMTs and a vertical DOM-to-DOM spacing of 7 m and a horizontal string-to-string spacing of 72 m (the uppermost 10 DOMs of ICDC will have a 10 m vertical spacing). In contrast, IceCube spacings are 17 m and 125 m, respectively. The ICDC DOM spatial density will thus be higher by about an order of magnitude than standard IceCube DOMs, making it more capable of detecting sufficient light from compact, low energy neutrino interactions in order to perform reliable reconstructions. In its position at the bottom center of IceCube, ICDC is surrounded by 37 layers of DOMs above and 3 layers of strings in all horizontal directions. The requirements for cables, power and readout are identical to other IceCube strings. While superior in sensitivity, it requires much less power than the AMANDA array.

3.4.2. Optical, Radio and Acoustic Technologies for Cosmogenic Neutrinos Enhanced

Capabilities. Coincident events between novel radio or acoustic sensors and an optical detector component could be used to bootstrap these technologies, reduce systematic errors and cross calibrate the novel techniques with the well understood optical detector system. While worldwide there are many initiatives on novel neutrino detection methods (e.g. RICE, ANITA, SalSA, ONDE) the IceCube site is the only place where this bootstrapping can be achieved within the foreseeable future.



4. Management Approach

Our approach to IceCube M&O—from science event to publication—is to maximize scientific discovery potential by drawing on talent and resources from Collaboration institutions to support both M&O and science tasks. The first part of this section (Section 4.1) describes how we are organized to perform the M&O functions for IceCube in this distributed model and how we provide accountability for task execution. The second part (Section 4.2) identifies the tasks required to meet the technical requirements and specifications discussed in Section 3, and explains how we perform each task.

4.1. Organization

The IceCube M&O management organization integrates the IceCube Collaboration and the Host Institution, University of Wisconsin-Madison (**Figure 4.1-1**). The Principal Investigator is responsible to the UW Vice Chancellor for Research and the National Science Foundation for the overall scientific direction of the IceCube Neutrino Observatory. The Collaboration Spokesperson appoints collaborating scientists to serve as the coordinators in each of the major M&O functions: Physics Analysis, and Research and Development. These appointments are subject to the concurrence of the Collaboration. The Director of Operations appoints technical professionals to serve as managers of the two M&O functions that are predominately centered at UW-Madison: Detector Maintenance & Operations and Computing & Data Management. The managers in these areas work with their scientific counterparts to ensure the detector operates reliability and the data taken by the detector can be analyzed in a timely way.

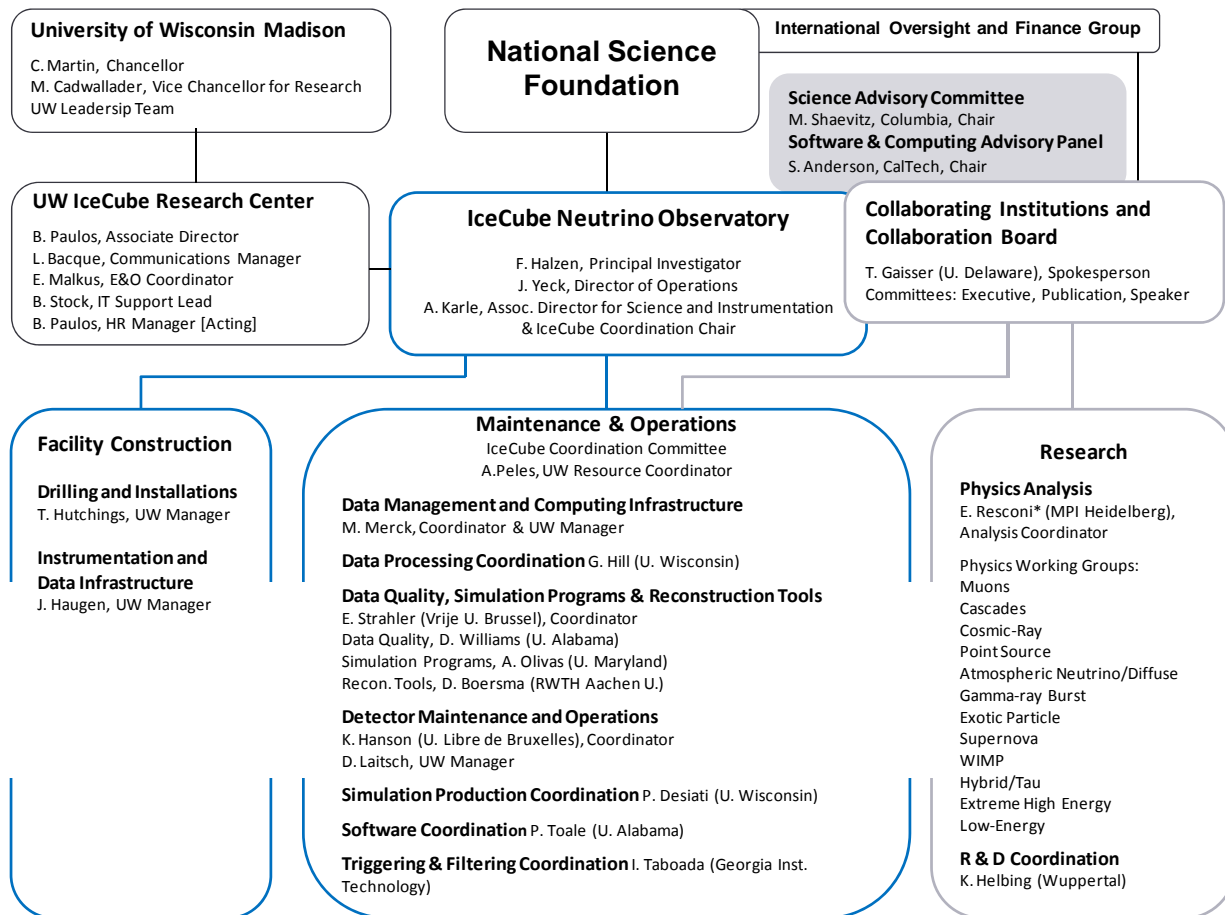

*Member of the IceCube Coordination Committee

February 9, 2011

Figure 4.1-1. IceCube Organization. *Our organization maximizes the use of both Collaboration resources and Core resources managed by UW while maintaining clear lines of accountability to the NSF.*



The IceCube Spokesperson and the Director of Operations are jointly responsible for the success of the IceCube M&O program with the Spokesperson directly accountable to the Collaboration and the Director of Operations accountable to the National Science Foundation through the University of Wisconsin-Madison as the host institution for the M&O program.

The Spokesperson-appointed coordinators and the Director of Operations-appointed managers are successful through the efforts of collaborating scientists, technical professionals, and managerial and administrative support staff. The entire M&O scope of work is sorted in a Work Breakdown Structure - WBS (included as Appendix 1 to this plan), and the WBS tasks are defined in a detailed Memorandum of Understanding (MOU) approved by the IceCube Collaborating institutions.

Every task in the MOU is assigned to an institution. The Principal Investigators (PI) at the institutions are responsible for ensuring that the work is completed on schedule. If an institution is not able to fulfill an agreed upon commitment the Institutional PI is responsible for ensuring that the work is assigned to another institution before there are adverse impacts to the M&O program. The Institutional MOUs also include a list of the physics group members and a head count of faculty, scientists, postdocs and graduate students. The Institutional MOUs are revised twice a year at the IceCube Collaboration Meetings. (A summary of the most current MOU headcount and level of committed contribution is included as Appendix 2 to this plan).

4.1.1. The U.S. National Science Foundation (NSF)

The NSF is the Executive Agent with responsibility for seeing that the IceCube detector meets its objectives, requirements and technical performance. The NSF has a special role in IceCube because of its Host Laboratory responsibilities in managing operation of the Amundson-Scott South Pole Station. These responsibilities include safety; physical qualification; transport of personnel, fuel and equipment; and the provision of housing, food service, support personnel, logistical support, IT support, and general infrastructure support.

Division of Acquisition and Cooperative Support (DACS)

The NSF Division of Acquisition and Cooperative Support (DACS) has formal responsibility for the Cooperative Agreement between the NSF and the University of Wisconsin-Madison. DACS works closely with the NSF Research Directorate(s) that provides the primary oversight of the award. DACS has formal approval authority for changes of key personnel and other matters as contained in the Cooperative Agreement. Formal communications are maintained between DACS and the UW-Madison Office of Research and Sponsored Programs.

Office of Polar Programs (OPP)

Within the NSF, the Office of Polar Programs (OPP) is the lead organizational unit responsible for conduct of the Maintenance and Operations (M&O) of the IceCube Neutrino Observatory. OPP works in partnership with the Directorate for Mathematical & Physical Sciences (MPS) and the IceCube M&O Program is co-funded by the OPP Antarctic Astrophysics and Geospace Sciences program (AAGS) and the Particle and Nuclear Astrophysics program (PNA). The program managers provide continuous oversight and guidance through direct communication with the UW IceCube Director of Operations and Principal Investigator; site visits to UW and other sites, including the South Pole Station. The Director of Operations will serve as the point of contact for the NSF cognizant program managers, including providing notification of any critical issues such as changes in key personnel, cost, schedule, and management structure or procedures prior to implementing such changes. A close working relationship between the program managers and IceCube Director of Operations is critical for the success of the operations. The organizational lines of communication between the NSF and the IceCube Organization are shown in **Figure 4.1.2**.



The NSF OPP is responsible for construction, maintenance and operation of the infrastructure and facilities at the South Pole and for logistics support, life safety and environmental protection.

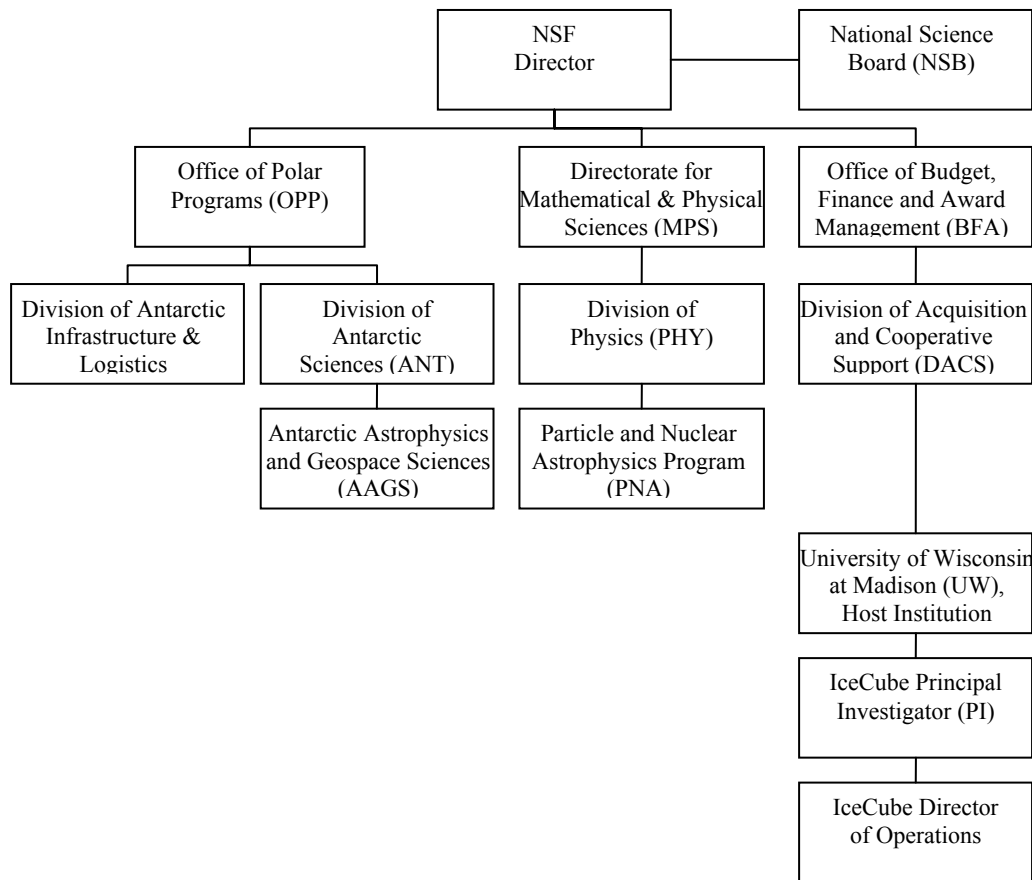

Figure 4.1.2. Lines of Communication between NSF and IceCube Organization.

4.1.2. International Oversight and Finance Group (IOFG)

The International Oversight and Finance Group (IOFG) was created in 2004 to provide oversight and financial support for the IceCube Neutrino Observatory (including Construction phase, Maintenance & Operations and Research phases). The Group organizes annual oversight reviews of the operations and meets annually to discuss detector performance and physics. The Group also sets policies for receiving periodic progress reports on all aspects of the detector operation and by all the performers in the collaboration, and for conducting external reviews when appropriate.

Membership

A representative of the National Science Foundation chairs the IOFG. Membership is comprised of representatives of the funding agencies in the partner countries supporting the construction and operation of IceCube Neutrino Observatory, currently the funding agencies from Belgium, Germany, Sweden, and the United States. The IOFG is informed by the Spokesperson of the Collaboration, the Director of Operations, the Principal Investigator and others as appropriate.



Decisions

The IOFG is committed to operate through discussion and consensus. The Executive Agent (the NSF) will make final decisions on matters before the group related to the operation of IceCube.

Issues that may come before the Group include:

- Approval of a formal charter for the Group.
- Review of Memoranda of Understanding (MOU) between the various institutions.
- Concurrence on the Maintenance and Operations Plan.
- Funding issues.
- Concurrence on the Collaboration's plans for new membership in the collaboration.
- Data sharing and data management policies.
- Coordination regarding press releases and education and outreach activities.
- Input on seasonal flight and personnel logistics planning.
- Other matters related to successful operation of the IceCube Neutrino Observatory for science.

4.1.3. University of Wisconsin-Madison

IceCube Oversight. The lead executive officer of the University of Wisconsin-Madison is the Chancellor. The Chancellor delegates responsibility for research activities to the Vice Chancellor for Research. The Vice Chancellor for Research maintains oversight of the IceCube Neutrino Observatory and appoints the IceCube Director of Operations.

The IceCube Principal Investigator and the Director of Operations report directly to the Vice Chancellor for Research and report regularly, typically quarterly, to the university's IceCube leadership team. The leadership team includes the Chancellor, Provost, Vice Chancellor for Research, and Vice Chancellor for Administration/Budget, Planning & Analysis. The meetings are called by the Vice Chancellor for Research and provide a forum for the IceCube Principal Investigator and the IceCube Director of Operations to inform the university leadership team of significant issues pertinent to the management of the IceCube Neutrino Observatory. The Director of Operations contacts the Vice Chancellor for Research when significant developments occur or important issues arise.

The IceCube Associate Director for Science and Instrumentation reports to the Director of Operations and advises primarily on matters related to science, coordination committee and instrumentation.

IceCube Research Center. The IceCube Operations Organization is located within UW's IceCube Research Center (IRC). The IRC is the primary interface to the university administrative and support systems, established within the Graduate School to coordinate the multiple roles of the university:

- Lead institution for the IceCube Construction Project;
- Host institution for initiating and continuing IceCube Maintenance and Operations;
- Provide administration services such as accounting, purchasing, human resources.
- Coordinating institution for IceCube Education and Outreach activities;
- Coordinating institution for Research and Development directed at technologies for increasing the IceCube neutrino detection volume; and
- Collaborating institution with the largest participating research group.

The IceCube Research Center will continue deliberate efforts to increase the presence in IceCube of underrepresented minorities and women who already form a significantly larger than typical fraction of IceCube faculty, scientists and students at UW-Madison.



4.1.4. IceCube Collaboration

The Collaboration plays a leading role in IceCube, guiding both science and M&O. The benefits of this distributed organizational model are 1) the ability to draw highly qualified and specialized personnel from Collaboration institutions to perform specific tasks in support of science or M&O, and 2) the education and training opportunities through hands-on IceCube participation for faculty, postdocs and students from multiple Collaboration institutions. The institutions collaborating in the IceCube Neutrino Observatory are listed in the IceCube Governance Document (included as Appendix 3 to this plan).

IceCube Collaboration Board. The IceCube Collaboration Board (ICB) is the policy-making entity that guides and governs the scientific activities of the Collaboration. It consists of a representative from each collaborating institution as described in detail at the IceCube Governance Document (included as Appendix 3 to this plan). It establishes, and as necessary, amends governance procedures and has oversight and authority over science policy and goals, membership, data access, publications, representation of IceCube at topical and general conferences, analysis teams, and education and outreach. The Principal Investigator is an ex-officio member of the Collaboration Board.

Executive Committee. The Spokesperson, in consultation with the Collaboration Board, the PI and the Director of Operations, appoints and chairs an Executive Committee of the Collaboration Board (**Figure 4.1-3**). The term of the members is two years. The job of the Executive Committee is to advise the Spokesperson in proposing actions to the Collaboration Board and in making interim decisions. The members of the Executive Committee represent major groups, functions and competences within the Collaboration.

	Name and Institution	Area of Expertise/Responsibility
Spokesperson	Tom Gaisser, University of Delaware	Cosmic-ray Physics, Overall direction of IceCube Collaboration
Member	Albrecht Karle, University of Wisconsin	All aspects of detector operation, Associate Director for Science & Instrumentation, liaison with R&D
	Dave Nygren, Lawrence Berkeley National Laboratory	Hardware design and innovation, Member of NAS/Generalist
	Lutz Koepke, Universität Mainz	High-energy experiments, Supernova subsystem
	Per Olof Hulth, Stockholm University	Neutrino physics, Lead for Deep Core Sub-array
	Greg Sullivan, University of Maryland	Neutrino and gamma-ray astronomy, MRE Lead for Data Systems
	Doug Cowen, Penn State University	Neutrino astronomy / L2 Lead for Verification in MREFC
	Daniel Bertrand, Université Libre de Bruxelles	High-energy experiment / Detector operations
Ex-Officio Member	Francis Halzen, Principal Investigator, University of Wisconsin	Neutrino astronomy & high-energy physics, overall scientific direction
	Christian Spiering, former Spokesperson, DESY Zeuthen	Neutrino astronomy, operations & strategy
	James Yeck, Director of Operations University of Wisconsin	Project and Operations Management, NSF Primary Contact for IceCube Operations

Figure 4.1-3. Executive Committee of Collaboration Board.

IceCube Collaboration Meetings. IceCube Collaboration meetings are held at least twice a year with one meeting in Europe and one in the United States. These meetings serve as a forum for the presentation of scientific results, and for communicating project progress and status to the entire collaboration. Official Collaboration Board meetings are conducted during these meetings.

Collaboration Institution Tasks. Tasks will be rotated in a fair and equitable manner, taking account of the special interests and capabilities of each institution. Tracking and transparency is provided as part of the MOU Scope of Work Summary (included as Appendix 2 to this plan). This summary matrix provides a breakdown of tasks by WBS Level 2 and by collaborating institution that provides the foundations of the MOU with each institution.



4.1.5. Key Personnel

Our key personnel form the leadership team that ensures the success of the IceCube M&O and the timely exploitation of its scientific discovery and education and outreach potential. This section discusses the roles and responsibilities of these personnel. Key personnel (**Figure 4.1-4**) are employees of the Host Institution, University of Wisconsin-Madison. UW-Madison will seek concurrence from the NSF prior to any changes in the appointments.

Name	Position	Responsibilities
Francis Halzen	Principal Investigator	Responsible for the overall success of the IceCube Neutrino Observatory
James Yeck	Co-Principal Investigator, Director of Operations	O&M of IceCube facilities to ensure operations meet established performance goals and the needs of NSF and the IceCube Collaboration
Albrecht Karle	Co-Principal Investigator, Associate Director for Science and Instrumentation	Technical performance of the IceCube detector infrastructure and ensuring that it meets IceCube science objectives

Figure 4.1-4. IceCube Key Personnel.

4.1.6. Advisory Committees

4.1.6.1. Science Advisory Committee

In consultation with the collaboration, the Principal Investigator and the Spokesperson appoint a Scientific Advisory Committee (SAC) of external experts. The role of the SAC is to make recommendations on the IceCube scientific goals and on any other matters that may affect the scientific activities of the IceCube Neutrino Observatory. The SAC meets annually. The current Chairperson is Michael Shaevitz from Columbia University.

4.1.6.2. Software & Computing Advisory Panel

The IceCube Software & Computing Advisory Panel (SCAP) is composed of experts in the fields of software development and scientific computing. The SCAP advises the IceCube Spokesperson and Director of Operations on the most efficient and effective computing resources for IceCube, including on-line computing; on-line and off-line data processing and filtering; off-line computing facilities; and simulations and analysis tools support. The Spokesperson and the Director of Operations appoint the SCAP members and the Chairperson. Meetings are held once each year. The current Chairperson is Stuart Anderson from California Institute of Technology.

4.1.7. M&O Coordination Boards and Organizations

The purpose of coordination organizations is to ensure that M&O tasks from raw data to publications are properly planned and executed. These organizations make certain that the resources committed in their areas of activity are realized and used efficiently and effectively. Examples include the following.

4.1.7.1 Coordination Committee.

The role of the Coordination Committee is to provide high-level coordination of IceCube M&O, analysis, and R&D. The committee is chaired by the Associate Director for Science and Instrumentation and is comprised of the Spokesperson-appointed coordinators (shown in **Figure 4.1-1**), UW M&O managers, and others as needed. The committee typically meets on a monthly basis to address technical and resource issues, and to advance strategic goals. The committee is the primary point for determining priorities and resolving resource conflicts that arise at lower levels in the organization. Issues that cannot be resolved by the Coordination Committee are resolved by the Spokesperson and the Director of Operations.

4.1.7.2 Trigger Filter Transmit (TFT) Board.

The role of the TFT Board is to maximize transmission of scientifically valuable data within the constrained resources of the South Pole system in support of IceCube's scientific objectives. It coordinates proposals for and execution of new technologies and software to continuously enhance detector output.



4.1.7.3 Detector Operations Coordination Committee.

This committee ensures that Collaboration resources committed in MOUs for critical detector M&O functions are provided as required and performing effectively. It also identifies resources within Collaboration institutions and in the M&O organization to resolve detector operational issues and provides oversight of issue resolution.

4.1.7.4 Analysis Coordination Working Groups.

The responsibility of the Working Groups is to provide a framework for coordinating analysis with operations and technology development for an integrated focus on IceCube science and technology issues and needs. The Working Groups provide specialized expertise and general support to M&O tasks that include maintaining the data warehouse; developing data preparation scripts; and supporting detector calibration and verification of its performance. Tasks for each collaboration member are described in general in their MOUs. The Collaboration assigns a leader responsible for each functional area to coordinate Collaboration institution resources in that area

4.1.8. Milestones

The following table presents IceCube annual Maintenance and Operations milestones (**Figure 4.1-5**).

Milestone	Month
Provide NSF and IOFG with the most recent Memorandum of Understanding (MOU) with all U.S. and foreign institutions in the Collaboration.	September 2010
Develop and submit for NSF approval, the IceCube Maintenance and Operations Plan and send this plan to each of the non-U.S. IOFG members for their oversight.	January 2011
Annual South Pole System hardware and software upgrade.	January 2011
Revise the Institutional Memorandum of Understanding Statement of Work and PhD Authors Head Count for the Spring Collaboration Meeting	April 2011
Submit to NSF a mid-year interim report with a summary of the status and performance of overall M&O activities, including data handling and detector systems.	March 2011
Annual Software & Computing Advisory Panel (SCAP) Review	April 2011
Report on Scientific Results at the Spring Collaboration Meeting	April 2011
Develop and submit for NSF approval a plan for data sharing and data management that is consistent with guidance from the IOFG and with NSF data policy.	April 2011
Annual Scientific Advisory Committee (SAC) Review.	May 2011
Submit for NSF approval an annual report which will describe progress made and work accomplished based on objectives and milestones in the approved annual M&O Plan.	September 2011
Revise the Institutional Memorandum of Understanding Statement of Work and PhD Authors Head Count for the Fall Collaboration Meeting	September 2011
Report on Scientific Results at the Fall Collaboration Meeting	September 2011
Annual Detector Up-Time Self Assessment	October 2011

Figure 4.1-5. Maintenance & Operations FY2011 Milestones.



4.1.9. Reports and Reviews

The IceCube Neutrino Observatory reports are distributed within the IceCube Organization and Collaboration, host institution, various IceCube advisory and oversight committees, and are submitted to the National Science Foundation.

Annual Report. The annual report will describe progress made based on objectives in the annual M&O Plan. Significant differences between planned and actual accomplishments will be discussed. The report will consist of a summary of work accomplished during the reporting period, including major technical accomplishments and an assessment of current or anticipated problem areas and corrective actions, and progress in the area of project governance.

Interim Report. The mid-year interim report will include a brief summary of the status of all M&O activities, including a section on the overall status and performance of the data handling and detector systems. It will also include highlights and accomplishments, specific comments on detector performance such as uptime and scheduled maintenance, failures, software releases and test results, major procurements planned or placed, an assessment of the overall labor effort, and any other performance data that is needed to characterize the overall data system performance.

Final Report. The final report will include a summary of all 60 months of the IceCube M&O award.

Common Fund Annual Report. The Common Fund (CF) Report is prepared by the IceCube Resource Coordinator on an annual basis and is submitted to the IceCube Board (ICB), the IOFG and NSF. The IceCube M&O Common Fund was created to enable collaborating institutions to contribute to the costs of maintaining the computing hardware and software required to manage experimental data prior to processing for analysis. The Common Fund report summarizes the past CF contributions, expenditures and the remaining funding available. The report also describes future plans for M&O CF contributions and expenditures during the coming year, including the major upgrades to the South Pole System (SPS), South Pole Test System (SPTS), UW Data Warehouse and UW Data Center.

Annual Reviews. NSF conducts annual reviews of the IceCube Maintenance & Operations activities through site visits of cognizant Program Officers. The review will address management issues, cost and performance objectives, and scientific and technical performance, and usually occurs in the spring of each year just after the Spring Collaboration meeting and the Science Advisory Committee meeting. The NSF may also conduct site visits and reviews on special topics.



4.2. Maintenance and Operations Plan

Building on our experience over more than three years, we have developed a plan to maintain and operate the detector and manage our collaboration resources to go from raw data to physics publications in a timely and efficient manner. Our plan maximizes IceCube's scientific potential and educational value by distributing both analysis and M&O tasks among collaborators. This structure draws the best expertise from collaborating institutions while also offering opportunities to educate scientists and engineers through hands-on experience with IceCube.

We provide accountability mechanisms in MOUs and strong leadership to coordinate distributed resources. In this section we present our plan by explaining how we will perform each task required to meet the technical requirements and specifications described at a top level in Section 3 and listed in detail in this section.

The Operations Organization has five primary elements: Program Management, Detector Maintenance & Operations, Computing & Data Management, Triggering & Filtering and Data Quality, Reconstruction & Simulation Tools:

- 1) Program Management: Management and Administration, Engineering, Science and R&D Support, Software Coordination, Coordination of Education and Outreach, Distributed Computing infrastructure, and other services typically provided by a scientific host laboratory.
- 2) Detector Maintenance & Operations: Run Coordination and Winterover Personnel, Data Acquisition (DAQ), Online Filters (PnF), South Pole System (SPS) and South Pole Test System (SPTS), Experiment Control (IceCube Live), Monitoring, Calibration, IceTop Operations and Supernova Operations.
- 3) Computing & Data Management: filtering data at South Pole for satellite transmission, incorporating data into the Data Warehouse; maintenance of Data Warehouse and UW Data Center and support the Distributed Computing infrastructure. Maintenance of data archiving system, networking and security infrastructure, core online/offline software code repository and build system; simulation production software and coordination for the production data stream and simulation stream, maintain data processing software and verification software framework.
- 4) Triggering & Filtering: coordination of the Trigger, Filter and Transmission (TFT) board and develop and verify Physics Filters and code for pole filtering. The TFT board evaluates proposals and executes plans to ensure that the IceCube detector operates in a configuration that meets the physics needs of the Collaboration while ensuring that the limited resources available from the South Pole System are utilized.
- 5) Data Quality, Reconstruction & Simulation Tools: managing Simulation Software tools and maintain detector simulation software (IceSim), maintain and verify simulation of Event Generation, Photon Propagation and Geometry Calibration. Develop core common Reconstruction Tools in order to process raw waveform data to ultimately reconstruct muon tracks, shower events, direction, energy, and background probability of in-ice events, as well as to reconstruct cosmic-ray air showers. Develop and maintain high level Analysis Tools to maximize the efficiency of turning reconstructed data into physics results. Perform Data Quality checks to support final selection of science-ready data and coordinate, develop and monitor common reconstruction for Offline Data Processing.



4.2.1. Program Management

4.2.1.1. Program Administration

The primary program administration task is to ensure that the resources needed to perform each task, regardless of source, are available when needed and used efficiently to accomplish the task requirements and achieve IceCube’s scientific objectives.

Operations Management and Science Support. We provide leadership to manage the effectiveness and efficiency of all services and ensure communication among the Collaboration, NSF, partner funding agencies, and the M&O functions. We prepare strategic plans and conduct formal risk management to achieve objectives.

Computing Infrastructure Management. We manage computing resources to maximize uptime of all computing services and availability of required distributed services, including storage, processing, database, grid, networking, interactive user access, user support, and quota management.

Financial Management. We manage IceCube finances, including NSF funding, a Common Fund supported by cash and invoice payments by European and Asian Pacific collaborating institutions, and in-kind contributions from collaborating institutions, providing accountability through an audit trail for all funds regardless of source.

Performance Management and Reporting. We establish objective performance measures in cooperation with NSF, which are meaningful to evaluating our performance against M&O objectives. Performance measures are in **Figure 4.2.1-1**.

Key Performance Indicator	Annual Objective	Rationale
Detector Uptime	99%	Key performance measure of time that the detector was sensitive to transient astrophysical events or signals
Detector Clean Uptime	95%	Key indicator of production of pristine data for physics analysis with no contamination and no serious alerts
Monitoring & Paging Uptime	99.9%	Critical to detection of problems that impact detector performance and quality of data
IceCube Live Uptime	99.9%	Critical to ability to resolve detector performance issues
South Pole System Uptime	99%	Critical to collection and storage of data

Figure 4.2.1-1. Proposed Performance Measures

4.2.1.2. Engineering and R&D Support

The engineering and R&D tasks are limited to the minimum tasks required to support day-to-day operations of the detector. R&D supports efforts to address Electromagnetic Interference (EMI) in the Dark Sector, enhancements to the performance of the IceCube Laboratory electronics and computing, and the ability to interface with externally funded R&D activities, especially those that intend to use the IceCube facilities.

4.2.1.3. USAP Infrastructure Support

IceCube personnel prepare detailed support requirements and identify the most cost effective approach to meeting the requirements, either through the annual planning cycle, direct communication with NSF Support Contractor, and the submission of the Support Information Package (SIP).

4.2.1.4. Education and Outreach (E&O) Coordination

As a part of Collaboration MOUs, each member contributes support to E&O. The E&O Coordinator working with NSF and IceCube leadership establishes E&O priorities, provides support to ongoing activities and responds to outside requests that support priorities by identifying appropriate resources within the collaboration, assigning tasks and providing oversight. **Figure 4.2.1-2** describes examples of ongoing and high-impact IceCube E&O activities.



E&O Activity Title	Description	Benefit
Support to Upward Bound Program	National, basic skills summer program for underrepresented high school students	Emphasizes importance of science and scientific opportunities to underrepresented groups
Support to Pre-service Teachers	Mentoring of pre-service teachers by South Pole-expert Master Teachers	Extends educational value of IceCube exponentially by engaging new teachers
Support to Polartrec	NSF-funded outreach program that pairs polar researchers with teachers	Provides new teachers in-depth science & technology training
Support to Post-doc Exchange	Mentoring by IceCube post-docs of undergraduates in research possibilities	Encourages undergraduates to pursue careers in basic science

Figure 4.2.1-2. Examples of E&O Activities.

4.2.1.5. Distributed Computing and Labor Reserve

A relatively small amount of M&O core support will be provided to U.S. collaborating groups on an ad hoc basis to leverage significant institutional Distributed Computing Infrastructure contributions. This will reduce the demand for centralized computing resources at UW.

4.2.2. Detector Maintenance and Operations

The IceCube Maintenance and Operations Coordinator is accountable for the overall performance of the people, hardware and processes required to execute the operational plan of the detector at the South Pole in order to gain high data quality, meet necessary data throughput rates, provide appropriate technical documentation, maintain a problem reporting system, maintain a software library and revision history, and demonstrate overall system sustainability.

The Coordinator holds weekly phone calls on run coordination and detector operations matters, prepares periodic reports to NSF, prepares budgets, manages expenses, serves as a member of the Coordination Board, resolves personnel matters, organizes planning for the austral summer, supports the SPTS, and is generally responsible for the overall coordination and performance of the detector through management of subsystem leads.

4.2.2.1. Run Coordination

During normal operations, the Run Coordinator ensures that data is being taken with high uptime and that the data is of the highest quality, with emphasis on data stability. The austral summer brings increased activity to the detector through planned maintenance of the computing networking and detector subsystems.

The Run Coordinator manages the activities of sub-system experts and operators both at the South Pole and in the Northern Hemisphere carefully documenting the run operation and auditing its effects on the data. Documentation and communication includes daily monitoring reports, daily reports of data transfers from the South Pole, e-mail alerts on error conditions, regular data verification reports, weekly Winterover reports, and other communications with stakeholders using a variety of media.

The South Pole System (SPS) requires full-time, on-site attention by two professionals who winter over at the South Pole Station each year in highly challenging conditions.

A dedicated Winterover manager coordinates the activities of the Winterovers, including training and activities at the South Pole. The manager prioritizes requests to Winterovers for support. Concurrent with the final months of the Winterovers on-site at the South Pole, two additional Winterovers prepare for the next season by training on system architecture, operating systems, and other key aspects of detector operations, and monitoring and maintenance. At the beginning of the three-month period in which the South Pole Station is open, the Winterovers prepare their replacements with hands-on experience and methodologies before their departure.



4.2.2.2. Data Acquisition (DAQ)

The DOMHubs and their internal components, as well as associated cabling, must be maintained to prevent malfunctions and repaired quickly if a breakdown occurs to minimize detector downtime and maintain a high quality of data. A DOMHub is fed by up to 64 DOMs. The Winterovers maintain and repair the DAQ hardware at the South Pole. The SPTS and PCTS DAQ hardware managers maintain and upgrade the system to improve functionality, designing upgrades and testing them in the SPTS prior to deployment at the SPS.

DAQ software collects raw hits from the individual DOMs, rejecting noise hits and forming triggers with all the relevant data for physics events in the detector. Diagnostic and calibration data is also collected as are raw counting rates for all DOMs, used for the supernova triggers. Performance of the DAQ software is a major driver of the quality of data for physics analysis.

DAQ software engineers are accountable for the uptime of the DAQ and the integrity, correctness and completeness of the data it produces. They also provide appropriate documentation for the operators.

Collaboration physicists from physics working groups, using Monte Carlo simulation of signals, develop new triggering algorithms for use in the DAQ. Physics working groups propose new trigger algorithms to the Trigger, Filter, and Transmission (TFT) Board. Once approved by the Board, the triggers are adapted, tested and deployed within the DAQ triggering system.

The DOM firmware consists of a low-level FPGA design responsible for controlling the DOM hardware. DOM Firmware Engineers supply required FPGA modifications, maintain the code base, and update documentation as needed. In addition, new physics requirements during the stable experimental program will require additional features in either the DOM or DOR FPGA designs.

Calibration runs are taken monthly, studied and fed into the main IceCube database. These results are then used as part of online reconstruction, affecting data rates and data selection by IceCube filtering. The Detector Operator is responsible for running DOMCal, with waveform calibration support to help interpret the results from DOMCal runs and to upgrade the DOMCal system as required.

Some DOMs have malfunctioned and must be operated as part of normal data-taking in a non-standard configuration. The typical solution is to bypass the failed or malfunctioning component within the DOM or to bypass the DOM completely. The Detector Operator, working with the Winterovers, excludes problem DOMs from the array and conducts DOM hardware maintenance runs and creates new standard run configurations as needed, tracking problem DOMs and performing studies on problem DOMs to develop solutions or workarounds that minimize impact of malfunctions on data quality.

4.2.2.3. Online Filters (Processing and Filtering—PnF)

The volume of data produced by the data acquisition system far exceeds the limited bandwidth available in IceCube's TDRSS satellite allowance. Instead of taping the entire data sample, an online filtering system is used to apply a set of first-level event selections to the collected data, transmitting only those selected events. PnF system expertise is required to maintain the online system, ensure filters are being properly applied, and respond to and debug unexpected errors.

The PnF system must collect triggered events from the data acquisition system, run any required calibrations and reconstruction algorithms, apply any filtering algorithms, write the data into a format that contains the results of reconstructions and filters applied, and categorize the output data into data sets for transmission and archiving. Collaboration physicists implement and test new online filters in advance of each new physics run after approval by the TFT Board. This process includes testing filters and working with filter proposal writers to ensure that filter designs achieve objectives and are properly implemented.



4.2.2.4. South Pole System (SPS)

The SPS architecture maximizes parallel operation to enable random asynchronous events to be observed and collected into meaningful physics data. The SPS hardware includes DOMHub computers, standard server class computers, calibration equipment, remote connectivity equipment, network hardware, and power supplies. Near-line storage for the system provides real-time buffering margins and increased fault tolerance through Redundant Array of Independent Disks (RAID) implementations. System administrators are responsible for hardware maintenance and operations of the South Pole computing hardware. The administrators respond to the support requirements of Winterovers, software developers and engineers to maximize hardware reliability and provide customized solutions to increase detector uptime. This includes preventive maintenance, troubleshooting, and upgrades.

SPS Computing Operating Systems within the IceCube Laboratory (ICL), is licensed through RedHat and is managed with RedHat Network (RHN). It allows system administrators and Winterovers to efficiently manage operating system version control, perform patching, software updates, monitoring and maintenance. Optimal configuration and operation of the local RHN server is critical to detector performance. System administrators and Winterovers are responsible for system maintenance, troubleshooting and upgrades for the South Pole computing base. RHN provides complete functionality to the South Pole computing base that subscribes locally to its services. These services include patch management, monitoring and system configuration control.

The IceCube network is the core fabric that integrates major project work groups, remote work sites, and ongoing operations. It provides secure connectivity through virtual private network (VPN) tunnels terminating at remote project endpoints. The network also operates in the public domain with exposed web, e-mail and database services. In addition, the IceCube network must interface to points of presence and comply with policies and regulations of NSF and the University of Wisconsin (UW). The IceCube Network Engineer is responsible for uptime and performance optimization of the IceCube network, including maintenance, support, configuration, and customization of the system when necessary. The Network Engineer also monitors the health of the devices and configurations to identify system bottlenecks and potential hardware problems. Security logs are monitored for suspicious behavior and traffic signatures. Corrective action is enforced according to NSF, project and UW policy.

4.2.2.5. South Pole Test System (SPTS)

The primary purpose of the SPTS is to build and test software in advance of operational deployment in the South Pole System (SPS). Software developers use the SPTS to debug system changes safely in a non-production environment. The close physical and logical match to the SPS allows system maintainers to verify hardware, determine precise cable routing and lengths, and identify potential system side effects introduced by software upgrades, configuration mismatches and environmental variables.

To test firmware and software changes, an assortment of hardware is used as part of a multifaceted approach to emulate conditions at the South Pole. IceCube system administrators are responsible for hardware maintenance and operations of the SPTS. During testing, system administrators support software developers and engineers to maximize hardware reliability and provide customized solutions to increase testing time. Computing hardware maintenance follows a three-year replacement cycle on backwardly compatible server class hardware. The SPTS DOM hardware managers maintain and upgrade the system to ensure maximum uptime when the system is required for testing. They provide support to users, software and hardware engineers to add features as required in response to evolving science needs and to improve the functionality of the SPTS as appropriate.

The SPTS Operating Systems software is licensed through RedHat and managed with RedHat Network (RHN). It allows system administrators to efficiently manage operating system version control, and perform patching, software updates, monitoring and maintenance. System administrators are responsible for system maintenance, troubleshooting and upgrades for the SPTS operating systems. These services include patch management, monitoring and system configuration control.

4.2.2.6. Experiment Control

IceCube Live Experiment Control System integrates control of all of the detector’s critical subsystems into a single, virtual command center. It provides an interface for monitoring the detector both via automated alerts and with interactive screens for displaying the current and historical state of the detector and associated subsystems. Web-based and command-line user interfaces provide maximum accessibility and flexibility to the operators located both locally at the South Pole and remotely in the Northern Hemisphere. IceCube Live is mirrored on the SPTS to test upgrades and changes before deployment.

The IceCube Live Software Engineer is accountable for uptime of IceCube Live and for maintaining, troubleshooting, supporting and evolving the interface to subsystems that control the detector. The Software Engineer continues to develop IceCube Live to integrate all subsystems, and add features as the behavior of the detector changes. During stable operations, the Software Engineer supports physics working groups and operators to add needed functionality and to respond to evolving science needs.

4.2.2.7. Detector Monitoring

IceCube Detector Monitoring (**Figure 4.2.2-1**) is the system that provides a comprehensive set of tools for assessing and reporting the data quality. It collects and analyzes raw subsystem data on the SPS immediately on completion of a run. It then sends results to the Northern Hemisphere via satellite where they are processed and presented through a web-based user interface. The system is critical to the ability to perform short-term and long-term analyses of detector performance.

The IceCube Detector Monitoring Developer/Coordinator is responsible for maintaining, troubleshooting, supporting and evolving the monitoring system. The Developer/Coordinator continues development of the system, adds features and improves algorithms for automated problem detection. During stable operations, the Developer Coordinator continues to coordinate monitoring among collaborating institutions and support physics working groups and users to improve user interfaces and system efficiency and functionality.

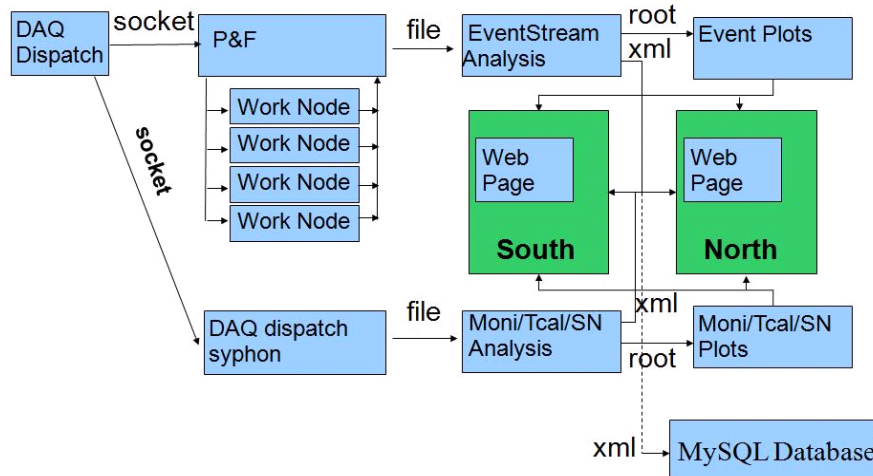

Figure 4.2.2-1. Data Flow of the IceCube Monitoring System. *The assimilation, display and historic archive of monitoring data enables the collection of high quality physics data.*

Detector Monitoring web pages summarize data in a tabular and graphical form and provide tools for the shift-takers to detect problematic DOMs and/or runs, compare data with the reference values, issue alerts and report any unusual detector behavior on a run-by-run basis. The monitoring shift compiles reports on detector performance during each shift and sends the reports daily along with an automatically generated list of identified problems to designated coordinators, managers and sub-system experts, who verify that the detector is operating as expected or take action to correct malfunctions.



The quality of IceCube data must be checked at multiple points in the data path to isolate and solve quickly any malfunctions that degrade data quality. The tests are performed at the South Pole on all acquired data, using local CPU power, and then the resulting histograms are transmitted to the Northern Hemisphere. Collaboration graduate students and postdocs perform the data quality verification tasks under the supervision of the Monitoring coordinator. A software engineer maintains the underlying code and supports upgrades and enhancements directed by the physics working groups.

Problems can occur with individual DOMs, groups of DOMs, DOMHubs (entire strings), or racks of DOMHubs (groups of strings). Detector operators must be alerted immediately when a problem occurs since the loss of a single DOM affects the overall quality of the data. Automatic alerting and automatic diagnosis of the problem help to limit the amount of time of a detector outage or degradation in data quality. The Detector Operator is responsible for overseeing development, maintenance and monitoring of the monitoring and paging system. During stable operations, the Detector Operator supports system administrators, Winterovers and users in improving the functionality of the system as appropriate.

4.2.2.8. Calibration

Every DOM includes a flasher board capable of generating light pulses of programmable intensity and duration. Flashers are enabled in special runs as needed to support ongoing studies relevant to physics data analysis. Operation of flasher runs requires tuning of flasher parameters to meet diverse requirements of studies related to detector performance. Substantial attention is required to minimize effects on detector uptime by fully exploiting capabilities of the hardware and DAQ software.

The Flasher Team is responsible for designing run parameters to meet requirements, executing the runs, validating the data, providing documentation of the runs, and providing technical assistance for corresponding simulation runs. The Flasher Team maintains a centralized repository of documentation relating to all flasher runs for general use by physics working groups.

The correct and efficient analysis of IceCube data relies on the use of a common set of calibrations and calibration tools. The IceCube Run Coordinator orchestrates many of these tasks since they either require inactivation of detector segments or illumination of the fiducial volume.

Collaboration graduate students and postdocs perform the specific calibration tasks under the supervision of the Run Coordinator. They perform regular calibrations of individual DOM responses to single photoelectrons and check that DOM timing resolutions remain at the required few nano second level. They regularly verify that the DOM-to-DOM local coincidence circuitry is performing correctly. Annually, they perform geometry calibrations with cosmic-ray muons to follow small displacements of the deepest DOMs due to ice flow.

4.2.2.9. IceTop Operations

IceTop by itself includes all aspects of a major experiment, requiring its own tools for calibration, monitoring, reconstruction and simulation. The environment for operation and the character of the data of the DOMs in IceTop are qualitatively different from those of DOMs deep in the ice. The IceTop DOMs are embedded in ice contained in tanks on the surface, which are subject to environmental changes that must be monitored. Data rates in individual DOMs are significantly higher, and typical signals are much larger than in the deep detector. In addition, specialized modes of operation are needed to capture the science accessible to a detector on the surface, which includes study of solar particle activity and high-altitude weather in addition to the basic cosmic-ray science.

The IceTop Data Specialist is the point of contact for all critical technical support personnel in IceCube operations. The Data Specialist coordinates monitoring of the physical condition of the IceTop detectors, including annual surveys of the tanks, snow accumulation above the tanks, and surrounding environmental conditions at the South Pole. The Data Specialist also coordinates monitoring the quality of IceTop data and any corrective actions required to address malfunctions or other conditions that degrade IceTop data.



4.2.2.10. Supernova Operations

Supernova data acquisition (sni3daq) picks up the single photoelectron trigger scalar data produced by IceCube DAQ software and looks for rate excess over the entire detector. For runs with no rate excess, the data is compressed to monitor the entire detector. In the event that an excess is found, an alarm is issued and sent via the IceCube Transport System (ITS) and more detailed data is saved. If monitors conclude that the alarm is significant, an additional alarm is sent to the Supernova Early Warning System (SNEWS).

The Supernova coordinator and operators are accountable for the uptime of sni3daq and for maintaining, troubleshooting, supporting and upgrading the system. Data acquisition, processing, transfer, storage and quality are monitored. The Supernova Working Group maintains a shift system to ensure that at least one monitor is checking alerts at all times.

4.2.3. Computing and Data Management

The Computing and Data Management Technical Coordinator is accountable for the overall performance of the people, hardware, software and processes required to support IceCube computing and data management from event to publication. The Coordinator holds weekly teleconferences on operations issues, provides input to status reports to NSF, prepares and manages budgets, serves as a member of the Coordination Board and develops long-term strategies to maximize the benefit to IceCube science from evolving computing and data management technologies.

4.2.3.1. Core Software Systems

The IceTray Core Analysis software framework, including a set of common classes for holding IceCube data, a set of basic modules, and a selected set of tools on which this system is based, is a part of the IceCube core software library. This core set is used in the development of calibration, simulation, reconstruction and analysis modules. A robust set of bindings to the Python programming language is also included, which facilitates use of advanced analysis environments and advanced 3-D graphical event displays. The IceTray Lead Architect is responsible for maintenance of IceTray and adaptation of its framework to new or updated operating systems and analysis tools. The Lead Architect maintains the software repository system, continuous-build testing system, and external libraries and build tools as newer operating system versions emerge. The Lead Architect also conducts regular training sessions for new collaborators and software contributors in the Collaboration.

The IceTray framework supports an advanced maximum likelihood estimation based fitting. This allows physicists to easily develop high-level reconstructions by defining event hypotheses and probability density functions (PDF) of the measured quantities. The framework also allows for the configuration of different minimization strategies and libraries to be used to construct high-performance and robust reconstructions. A scientist provides support for the reconstruction framework, tracks bugs and feature requests using an open source tracking system. Based on these requests, new releases are made available to the Collaboration on a regular basis. Training on the use of the reconstruction framework is conducted in connection with the new user training on the core IceTray framework.

Central databases with mirrors in key locations to enhance efficiency of data access store key IceCube information such as detector geometry, DOM calibration information, configuration information for DOM settings, configuration information for triggers, and run summary information. A lead developer maintains and extends the database tables and maintains all code to update and query the database. A database administrator supports reliable operation and monitoring of the database and tunes the database configuration for best access. The bi-directional update process is periodically updated and improved to minimize manual intervention. Standard monitoring of the database provides input for optimization to accommodate rapid growth in the quantity of stored data.



Simulation production in a varied set of computing environments including batch processing systems and open GRID clusters requires a dedicated middleware framework to coordinate dataset allocation and result tracking. The simulation production software, IceProd, keeps track of all datasets and distributes individual simulation steps among all available computing resources. It takes into account the individual capabilities available at the different sites and optimizes distribution of tasks to achieve the best use of the resources. A computer scientist maintains and adapts this system to allow easy configuration of the available resources and to adapt to individual policies and restrictions of distributed production sites.

A software engineer is accountable for maintaining, troubleshooting, supporting and improving the data processing software. The software for processing data for physics analysis is comprised of submission scripts for processing jobs to the compute elements of the central HPC cluster, processing scripts, database software to monitor job execution, and web pages to display processing progress and quality parameters. The software engineer adapts processing based on the required reconstruction algorithms developed by the Collaboration. The software engineer also adapts submission and execution monitoring to make the best use of the available computing resources.

A computer scientist is responsible for operating the central software repository that tracks all changes to the software developed by members of the Collaboration. The computer scientist uses a standard subversion software repository coupled with easy-to-use open-source management and monitoring tools as the basis for performing configuration management.

A research associate maintains the data quality verification framework and coordinates the development of new and expanded tests with the working groups. Quality of data in a complex experiment like IceCube is important to enabling the best physics results. A long list of tests has been developed to identify problems in data collected by the IceCube detector and to identify individual malfunctioning detector channels. This information is used at higher-level reconstructions and for final physics analysis.

4.2.3.2. Data Storage and Transfer

IT specialists monitor and archive the data transfer from the South Pole. Data is transferred from the South Pole using three mechanisms: 1) very small data samples over e-mail; 2) data up to hundreds of megabytes per day using the TCP/IP network; and 3) the bulk of the IceCube data over the dedicated high-capacity SPTR (South Pole TDRS Relay) system. All data is archived onto magnetic tape at the South Pole in two main tape sets. The raw data stream is archived in case of significant issues with online filtering or for temporally transitory data that may need re-analysis. To mitigate the risk of catastrophic failure of the SPTR system, another tape set is maintained to facilitate fast recovery from such a failure. Data transfers use the allowed bandwidth allocated to IceCube and buffer data for at least 3 days to compensate for any short-term outages of satellite connectivity.

A Software Engineer maintains the Data Transfer Software (SPADE). The SPADE application gathers data files from multiple clients at the South Pole, archives all files on magnetic tape, and transfers data from the South Pole at three different levels of speed/priority depending on the size and urgency of the file. As a distributed application, it runs on several servers and balances the transfer and processing requirements to archive a stable and sustained throughput from all clients to the tape systems and the different transfer channels.

A Software Engineer maintains the Ingest and web interface applications, including fixing bugs and adding new features to Ingest. The Ingest software application registers the arrival of each file from the South Pole in its catalog database as well as the contents of the metadata files that are paired with each data file. The Software Engineer expands Ingest and the web interface as necessary to provide user access to the catalog database including information on the status of each file produced at the South Pole.

Data from the detector is processed, analyzed, and stored in intermediate and final stages both on disk for fast access and on tape for long-term backup and archive. System administrators operate the data storage infrastructure and ensure that active data is available at several different levels depending on requirements for latency, throughput, and quantity.



4.2.3.3. Computing Resources

Core high performance computing (HPC) is the method required to process data transferred from the South Pole daily and to produce a core sample of simulation data. To obtain the computing resources required to process vast amounts of data, IceCube relies on distributed resources available from Collaboration institutions. This generates the need for coordination of these hardware resources in terms of interfaces such as GRID tools and general job scheduling and distribution. The increased usage of the existing GRID computing clusters in the US, Germany, Sweden and Belgium allow IceCube to produce simulation data at a much higher volume. This data must be transferred back to the central data warehouse using high-throughput links and the GridFTP protocol. The GRID resources must be managed locally for optimal utilization with local storage of intermediate results and optimal scheduling of processing steps.

Support personnel at all sites coordinate and manage the distributed computing effort to produce Monte Carlo datasets as required to achieve IceCube's scientific goals. In addition, an IT professional at the central IceCube datacenter manages the IceCube GRID middleware needed for the GRID access to the data. Standard GRID tools are used where possible to achieve high throughput of data from the distributed sites to the central IceCube computing center.

Systems administrators experienced in troubleshooting distributed computing systems maintain the HPC systems and support users working on HPC resources by giving guidance and advice on HPC use and coding best practices. The systems administrators support the delivery of science-ready data by ensuring that all incoming data is run through offline processing software, which produces the data filtered to appropriate levels for analysis, verification and monitoring purposes. IceCube also participates in the Grid Laboratory of Wisconsin (GLOW).

The IceCube Network Engineer is responsible for uptime and performance optimization of the IceCube network, which includes maintenance, support, configuration, and customization of the system when necessary. During operations, the Network Engineer responds to the needs of scientists, software developers, project engineers and detector operators to maximize network reliability and provide customized solutions to optimize performance. The Network Engineer monitors the health of the devices and configurations to identify system bottlenecks and potential hardware problems. Security logs are analyzed for suspicious behavior and traffic signatures.

Several systems administrators share duties to maintain the IceCube Data Center servers in addition to the HPC and data storage. This includes patching, monitoring, troubleshooting, and responding to user needs, among other routine tasks. IceCube requires a flexible and highly available set of computer systems to support operations. Some are highly visible, such as e-mail, web servers and home directories. Others operate in less visible but equally vital roles.

4.2.3.4. Data Production Processing

Data arriving in the north are compressed and stripped of all unnecessary information to conserve transfer bandwidth. In a first processing step, the data must be unpacked and uncompressed, and calibrations must be applied to these data to convert raw DAQ measurements into physical quantities. The reconstructions used at the South Pole to form the filter decisions must then be reapplied to the calibrated data and all intermediate results stored together with the data to allow studies of the filter performance. A software engineer monitors the execution of the processing scripts and verifies regularly the quality of the data.

The complex reconstructions required allowing the suppression of the high muon background from cosmic ray initiated air showers from the neutrino signal are computationally intensive. To make the best use of limited computing resources in the IceCube Collaboration, these reconstructions must be run centrally and results made available in the data warehouse for consumption by the different physics analysis working groups. A software engineer monitors the execution of the processing scripts and verifies regularly the quality of the data. Using a web interface, the software engineer also provides plots of reconstruction parameters to the Collaboration for quality assurance.



4.2.3.5. Simulation Production

Coordinate Simulation Production and Resources involves management of multiple dependencies across M&O and the Collaboration. These include, for example, detector geometry calibration, charge and time calibration, and detector configuration uploaded into the database; maintenance of simulation software; and physics demand and dataset priority agreed with the Collaboration and matched with current computing infrastructure capacity. The Simulation Production Coordinator is responsible for coordinating with other groups in the Collaboration to assess the impact of these tasks on physics analyses and understand issues involving computing infrastructure. The Coordinator ensures proper production of data to verify simulation releases before full production is enacted. The Coordinator also defines and reaches agreement on required computing capacity from each production site based on its capacity and infrastructure.

In order to detect physics events caused by high-energy neutrinos, the large background of cosmic muons events must be rejected while retaining the highest signal efficiency. Simulation data are essential in this analysis procedure and a large number of cosmic muon events must be produced. Trained personnel at each institutional production site are necessary to support the operation of simulation production and to make sure production daemons are properly set and running at the local site; submit and monitor datasets assigned to that site; and report issues and problems.

The highest degree of simulation complexity is the dependence on large lookup tables for the description of photon propagation fields in the ice. No machine in the distributed computing infrastructure has memory large enough to load all of the tables at once for processing. The addition of data filtering and processing adds further complexity. A physicist supports this task by performing runtime basic data checks to verify evident configuration errors; low and high level data verification by comparing simulation data from different production sites and different historical simulation releases to experimental data; and analysis-level data checks expected by working groups for the very early stages of physics analyses. The physicist maintains the simulation production web portal to keep all stakeholders informed of simulation production status and issues.

4.2.4. Triggering and Filtering

4.2.4.1. Trigger, Filter and Transmission (TFT) Coordination

The TFT Board's purpose is to evaluate proposals and execute plans to ensure that the IceCube detector operates in a configuration that meets the physics needs of the Collaboration while ensuring that the limited resources available from the South Pole System are utilized within their constraints in a controlled, consistent and efficient manner. The TFT Board Chair is responsible for organizing all TFT processes, including meetings, proposals and oversight activities. The Board issues a request for proposals, coordinates production of expected trigger and DAQ settings and Monte Carlo data sets, sets deadlines for physics working groups to draft proposals, and evaluates proposals to generate the standard data taking configurations. At each point in the process, the TFT actively involves the physics working groups to ensure that their needs are met by any changes and compromises required during the review process.

When preparing proposals for the TFT Board, Collaboration members require data sets (real data and Monte Carlo simulation). Minimally triggered samples are also required for new trigger algorithm development. A physicist is responsible for preparing the required datasets. Taking input from the TFT Board on expected DAQ and trigger settings, the physicist produces simulation and real data samples to match the expected settings.



4.2.4.2. Physics Filters

Each year, the filters that select events for immediate transmission to the Northern Hemisphere for further analysis must be evaluated to ensure that they meet the evolving physics needs of the Collaboration and that the most effective reconstruction and filtering tools are in use online. Collaboration physics working group members provide filters to the TFT Board for evaluation. They first research and write initial proposals, participate in internal working group discussions, make presentations to the TFT Board, and report on the filtered data quality. The filtering system must be approved by the TFT Board and ready for deployment at the start of each year.

Filters that operate in the online filtering system at the South Pole need to be verified and filtered data must be checked to ensure that filter output matches expectations from simulation predictions used in writing filtering proposals. Each year, the TFT Board calls for reports on the performance of physics filters. Members of Collaboration physics working groups perform filtered data verification using filter output data and data samples using the IceTray software framework and reconstruction tools. They submit reports with findings and recommendations to the TFT Board, which assigns any required follow-up actions.

4.2.5. Data Quality, Reconstruction and Simulation Tools

4.2.5.1. Simulation Programs

Continued development and improvements to IceCube Simulation Software (IceSim) are mainly the tasks of Collaboration physicists as part of this area. These improvements are made as we acquire a better understanding of the ice properties, implement new possible signals to search for, and work to reduce the simulation's CPU and memory usage. IceSim maintenance is performed to keep all elements of the simulation package current with changes in the computing environment. An expert simulation programmer/coordinator is responsible for coordinating all Collaboration effort on the simulation program to maintain continuity and control of the overall event and detector simulation packages. The programmer/coordinator tracks issues and helps to set priorities in development. This position also serves as the central point of contact for resolving build and operating system issues, tracking bugs, and coordinating troubleshooting to ensure accuracy of the detector simulation data, and speed, performance and reliability of the simulation package.

The physics of the generation of neutrino events and shower events, both in the atmosphere and in the ice, is an ongoing scientific field, as is the physics of neutrino and particle generation at possible astrophysical sources. The Simulation Manager is responsible for updating event generation parameters to enhance scientific output and system efficiency as IceCube science evolves.

IceCube reconstructs tracks by using the number and time of arrival of photons at the photomultiplier tubes or DOMs. An accurate model of the photon propagation is critical to our ability to reconstruct tracks. This task has two primary elements—modeling the ice properties and developing the photon propagation model from the ice property model. We continue to improve the ice properties model by using the data that was logged during drilling, and data gathered during flasher calibration runs and reconstructing muons.

Accuracy of the detector geometry is critical to the accuracy of physics analysis. Collaboration physicists run the DOM geometry software on various sets of data to determine precise DOM locations through analysis of flasher data and muon tomography.

4.2.5.2. Reconstruction and Analysis Tools

The IceCube detector provides calibrated and verified raw waveform data. This raw data must be processed to ultimately reconstruct muon tracks, shower events, direction, energy, and background probability of in-ice events, as well as to reconstruct cosmic-ray air showers. The physics discovery potential of IceCube is limited by the quality of these reconstructions.



The physics working groups evaluate evolving scientific objectives and priorities and improve existing reconstruction algorithms or develop new ones. They rely on data from the data warehouse, core software systems and reconstruction tools to improve angular resolution, signal efficiency, background rejection, physics reach and signal sensitivity.

IceCube science requires common, high-level analysis tools to maximize the efficiency of turning reconstructed data into physics results. This enhanced efficiency helps to reduce the time lag between data reconstruction and publication of results. Collaboration working group members propose development or modification of tools, develop the tools, work with M&O staff and resources to implement tools, and train users in their operation and maintenance.

4.2.5.3. Data Quality

IceCube detector operation is run-based with configuration defined for each run. Occasionally, runs are short or aborted at start, or may have significant faults. These runs must be identified and marked in the common database for exclusion from physics analysis. In addition, for each run there are occasionally DOMs that malfunction and must also be marked for exclusion from analysis. Collaboration physicists use information gathered from the run coordinator, run configuration database, monitoring software and verification software to create lists of problematic runs and DOMs. The lists are then imported into the database with tools and support from IceCube core software.

4.2.5.4. Offline Data Processing

The first levels of production processing, which are executed on every event and use significant computer and network resources, must be performed in common for all events for consistency of data for analysis. Collaboration physicists under the guidance of physics working groups, analyze calibrations, successful runs, malfunctioning DOMs, and common reconstructions to further develop common programs ready for mass production processing.

Production processing must be monitored to ensure that it is producing data of the high quality required for physics analysis. Collaboration physicists monitor the processing output data to ensure its quality and consistency, which is an indicator of the stability of the production processing code. They also monitor the length of time required for production processing to identify inefficiencies that waste computing resources.

4.2.6. Physics Analysis Coordination

Physics analysis includes tasks that are not included in the M&O Core and In-kind budgets but are essential to complete the process from science event to publication. These tasks are supported through research grants to the collaborating groups.

4.2.6.1. Analysis Coordinator

IceCube reaches its greatest potential both in achieving its scientific objectives and in education and outreach by balancing centralized M&O resources with resources distributed among Collaboration members and maximize the benefits of the specialized expertise of each collaborating institution, both in M&O and in analysis.

The distributed model is illustrated in **Figure 4.2.6-1**. Analysis tasks are divided among channel working groups and physics working groups. The channel working groups perform initial analysis at the level of the topology of the IceCube events. They also develop and benchmark new reconstruction algorithms, energy estimates and filtering scripts. The physics working groups develop the high-level analysis strategies as well as the specific tools needed to execute the analyses. The physics working groups also debate the statistical interpretation of results and updates on physics scenarios. IceCube data analysis is coordinated by the IceCube Collaboration under the leadership of the Analysis Coordinator, a position appointed by the Spokesperson with concurrence of the Collaboration Board. Analysis funding is provided directly to the IceCube collaborating groups by their respective funding agencies.

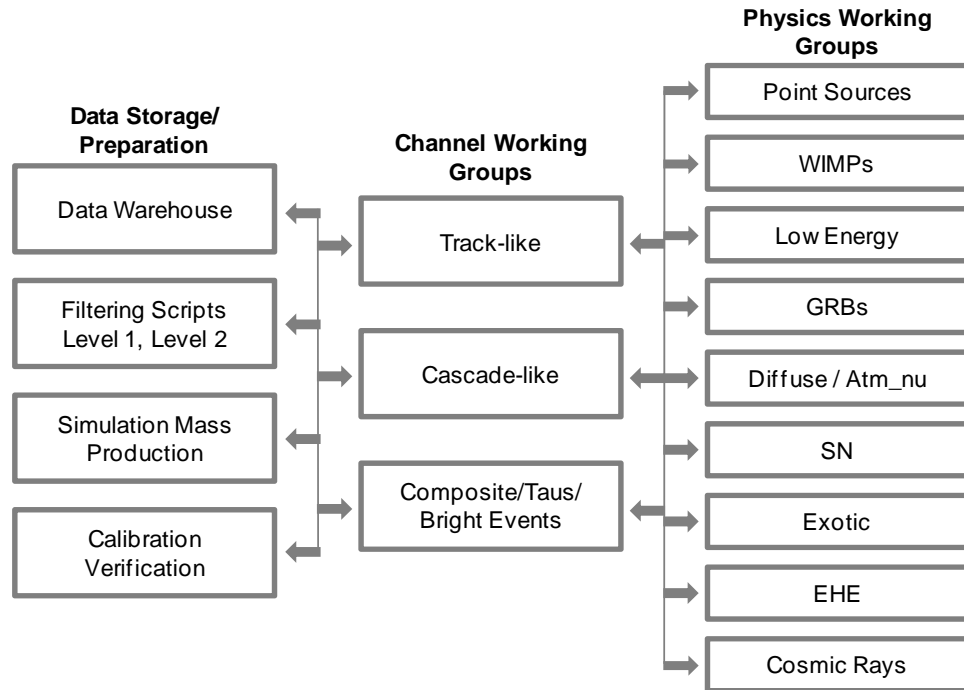

Figure 4.2.6-1. Data Analysis. Shown is a schematic view of the distributed data analysis organization and its connection with M&O data storage and preparation functions.

The Analysis Coordinator uses four primary communication mechanisms to coordinate analysis activities and ensure high quality data analysis using the best resources available to the Collaboration. The weekly data analysis teleconference discusses activities of the physics working groups and their connection with the channel working groups. The physics working groups hold biweekly teleconferences, supplemented by two weekly plenary teleconferences on topics of more general interest.

Conscious and unconscious biases can affect physics analysis resulting in the need for blinding of data. The blinding procedure for IceCube cannot prevent full exploration of the data, especially for calibration, verification and reconstruction. Moreover, in the event of multiple analyses of the same data sample, the unblinding of one analysis cannot bias the status of any other analysis. The IceCube Collaboration uses a blinding process for its analyses of data. It is neither centralized nor controlled by a specific authority; rather, the group assigned to perform the analysis is responsible for blinding the final answer while analysis procedures are being set. Once the analysis is approved by the Collaboration, the permission to unblind is granted, and the final results are produced.

4.2.6.2. Publication Committee

After discussion and positive reception by the Collaboration of the results of an analysis, a working group produces a draft paper with supporting web pages. To be acceptable, physics papers must have significantly better sensitivity than previous IceCube published results, and/or demonstrate a substantially improved method. The Publication Committee regulates and manages the review process for IceCube papers. It consists of senior physicists, the Analysis Coordinator and the Collaboration Spokesperson. The Publication Committee sets standards and procedures for publication of papers and conference proceedings to ensure a high standard of quality and integrity for IceCube scientific papers. Moreover, the Committee participates actively in the refereeing process of each paper and conference proceeding by organizing review panels.



5. Cost Overview

IceCube Maintenance & Operations finance management, includes NSF funding, a Common Fund supported by cash and invoice payments by European and Asian Pacific collaborating institutions, and in-kind contributions from collaborating institutions, providing accountability through an audit trail for all funds regardless of source.

5.1 Funding Sources

The new NSF IceCube five-year M&O award covers Federal Fiscal Years 2011-2015 (October 1, 2010 – September 30, 2015). NSF intends to provide a total of \$34,500,000 over the term of five years (\$6,900,000 per year), split equally between the OPP/ANT and MPS/PHY divisions. The expectation is that annual increases typically expected due to escalation will be off set by efficiencies in the program.

In addition to the new NSF M&O Award, the second source of funds for the M&O Core activities is the European & Asia/Pacific Contributions to the Common Fund (CF).

M&O Core Funds Source (\$k)	FY11	FY12	FY13	FY14	FY15
NSF M&O Award	6,900	6,900	6,900	6,900	6,900
Euro & Asia/Pacific CF *	805	805	805	805	805
Total M&O Core Funds	7,705	7,705	7,705	7,705	7,705

Figure 5.1-1. M&O Core Funds Sources (in \$K).

* Common Fund calculation is summarized in section 5.1.2

5.1.1 NSF IceCube M&O Award

The following three figures describe the NSF M&O Award Budget by Labor Resource (**figure 5.1-2**), by WBS Level 2 (**figure 5.1-3**) and by cost categories (**figure 5.1-4**).

	FY11	FY12	FY13	FY14	FY15
NSF Award – M&O Core Labor Plan (FTE)	31.51	32.01	30.35	29.45	28.50

Figure 5.1-2. NSF IceCube M&O Award - Labor (FTE).

The expectation is that over the five year period, several M&O core activities and responsibilities will be transferred to U.S. and Non U.S. In-Kind Contribution or will be reduced as a result of the maturity level of the detector systems.

WBS Level 2	FY11	FY12	FY13	FY14	FY15
Computing & Data Management	\$2,624	\$2,609	\$2,675	\$2,707	\$2,741
Detector Operations & Maintenance	\$2,386	\$2,411	\$2,408	\$2,428	\$2,455
Engineering, Software, Mgmt. Support	\$1,540	\$1,523	\$1,502	\$1,495	\$1,428
Data Quality, Reconstruction & Simulation Tools	\$294	\$302	\$286	\$270	\$277
Triggering and Filtering	\$55	\$56	\$29	\$0	\$0
IceCube M&O NSF Core Total	\$6,900	\$6,900	\$6,900	\$6,900	\$6,900

Figure 5.1-3. NSF IceCube M&O Award - Cost by WBS Level 2 (in \$k)

Cost Category	FY11	FY12	FY13	FY14	FY15
Labor	\$5,043	\$5,236	\$5,156	\$5,195	\$5,203
Capital Equipment (*)	\$80	\$45	\$45	\$45	\$45
Materials & Supplies	\$874	\$818	\$838	\$874	\$806
Travel	\$204	\$218	\$209	\$205	\$208
Service Agreement (Computing)	\$638	\$582	\$652	\$580	\$638
Overhead on first \$25K of 5 subawards	\$61	\$0	\$0	\$0	\$0
IceCube M&O NSF Core Total	\$6,900	\$6,900	\$6,900	\$6,900	\$6,900

Figure 5.1-4. NSF IceCube M&O Award - Cost by Categories (in \$k)

(*) Capital Equipment expenditures for computing infrastructure are mostly covered under Non U.S. Common Fund.



5.1.2 IceCube M&O Common Fund

The IceCube M&O Common Fund was created in April 2007, the start of formal operations, to enable collaborating institutions to contribute to the costs of maintaining the computing hardware and software required to manage experimental data prior to processing for analysis. Each institution contributes to the Common Fund based on the total number of the institution’s Ph.D. authors.

The Collaboration updates the Ph.D. author count twice a year at the Collaboration meetings in conjunction with the update to the IceCube Memorandum of Understanding for M&O. Effective April 1, 2010, the established rate per Ph.D. author was increased by 50% from \$9,100 to \$13,650.

Common Fund Expenditures

The M&O activities identified as appropriate for support from the Common Fund are those core activities that are agreed to be of common necessity for reliable operation of the IceCube detector and computing infrastructure. The activities directly support the functions of winterover technical support at South Pole, hardware and software systems for acquiring and filtering data at the South Pole, hardware and software systems for transmitting data via satellite and tape to the UW data center, systems for archiving the data in the central data warehouse at UW and UW Data Center Operations as listed in the Cooperative Agreement with NSF.

The Common Fund expenditures are divided into two categories: U.S. Common Fund and Non-U.S. Common Fund. This division was made to ensure that Non-U.S. CF is only used for hardware, software, and materials and supplies. A detailed list of the Common Fund expenditures under both U.S. and Non U.S. accounts, is provided as part of the Annual Common Fund Report.

Common Fund Contributions

The planned contributions during the fourth year of IceCube operations (April 2010 – March 2011), is larger than in preceding years primarily due to the 50% increase approved by the collaboration and supported by the funding agencies. There are also additional Ph.D. authors contributing to the total increase. The following table is a summary of the anticipated contributions.

M&O Year4	PhD. Authors, May 2010	Planned
Total CF Planned	127	\$1,733,550
U.S. Contribution	68	\$928,200
Non-U.S. Contribution	59	\$805,350

Figure 5.1-5. Planned CF Contributions For Year 4 of M&O, April 1st, 2010 – March 31st, 2011 Based on IceCube Institutional Memorandum of Understanding v8.3 (May 2010)

The following table provides a more detailed breakdown of the Authors headcount including faculty, scientists and postdocs, and PhD. students.

IceCube Authors Head Count	Total Ph.D. Authors	Faculty	Scientists / Post Docs	PhD. Students
Non-U.S. Institutions Subtotal	59	34	25	64
U.S. Institutions Subtotal	68	32	36	29
Total U.S. & Non-U.S.	127	66	61	93

Figure 5.1-6. IceCube Collaboration – Authors Head Count Based on the Institutional Memorandum of Understanding v8.3 (May 2010)



5.1.3 Institutional In-Kind Contribution

In addition to the M&O Core activities, IceCube MOUs secure In-Kind contributions of distributed M&O labor and computing resources from collaboration institutions of approximately 48 FTE per year of labor.

This represents a transition from a centralized management and funding approach during IceCube’s construction phase to a more distributed model of management and funding for M&O. (**Figure 5.1-7**).

The distributed model results in increased financial contributions to the Common Fund and in-kind labor contributions to M&O tasks from European & Asia Pacific collaborators. It also results in a greater emphasis on direct NSF funding to U.S. Collaborating institutions and a reduced fraction of funding to the central UW M&O budget. In-kind contributions by each Collaboration institution is included in the Memorandum of Understanding (MOU) with Collaboration members. (Summary of the MoU Scope of Work is included as Appendix 2 to this plan).

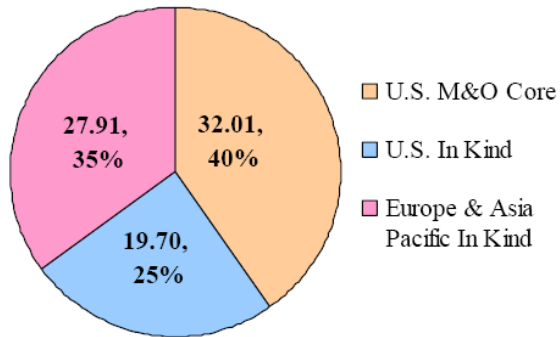

Figure 5.1-7. IceCube M&O Distributed Management and Funding Model (FY2012)

The M&O budgets are based on a detailed, bottom-up analysis of the costs required to complete each task in the M&O Work Breakdown Structure (WBS) (included as Appendix 1 to this plan). These costs are very well understood and are based on actual experience during the initial M&O phase. There is no explicit budgeting for contingency as was done for the MREFC project.

5.2 Computing Infrastructure Upgrade Plan

Computing infrastructure is the major cost driver in IceCube M&O Capital Equipment and Materials and Supplies expenses. The annual upgrade plan assumes consolidation of redundant computing storage infrastructure with an expectation to upgrade 25% of existing systems each year both at the South Pole and in the north, including supporting networking and other hardware such as tape drives for backup. The annual upgrade plan is presented and reviewed at the Software and Computing Advisory Panel (SCAP). The Materials and Supplies upgrade plan supports several different operational tasks such as sufficient tape media at the South Pole to store raw and filtered data, and sufficient tape media for the northern data center to back up the data and provide for online tape-based storage of the raw data. Other expenses include storage area network replacements and software purchases along the growth in storage requirements. Computing infrastructure and software both at the South Pole and at UW are also the major cost drivers for service agreements, which include licenses, operating systems, warranties, technical support and software programming consultants.

Appendix 4 includes a list of FY2010/2011 major IceCube purchases for the South Pole System (SPS) upgrade, for the South Pole Test System (SPTS) upgrade and for the UW Data Warehouse and UW Data Center upgrades.



Appendix 1: IceCube M&O Work Breakdown Structure

October 1, 2010

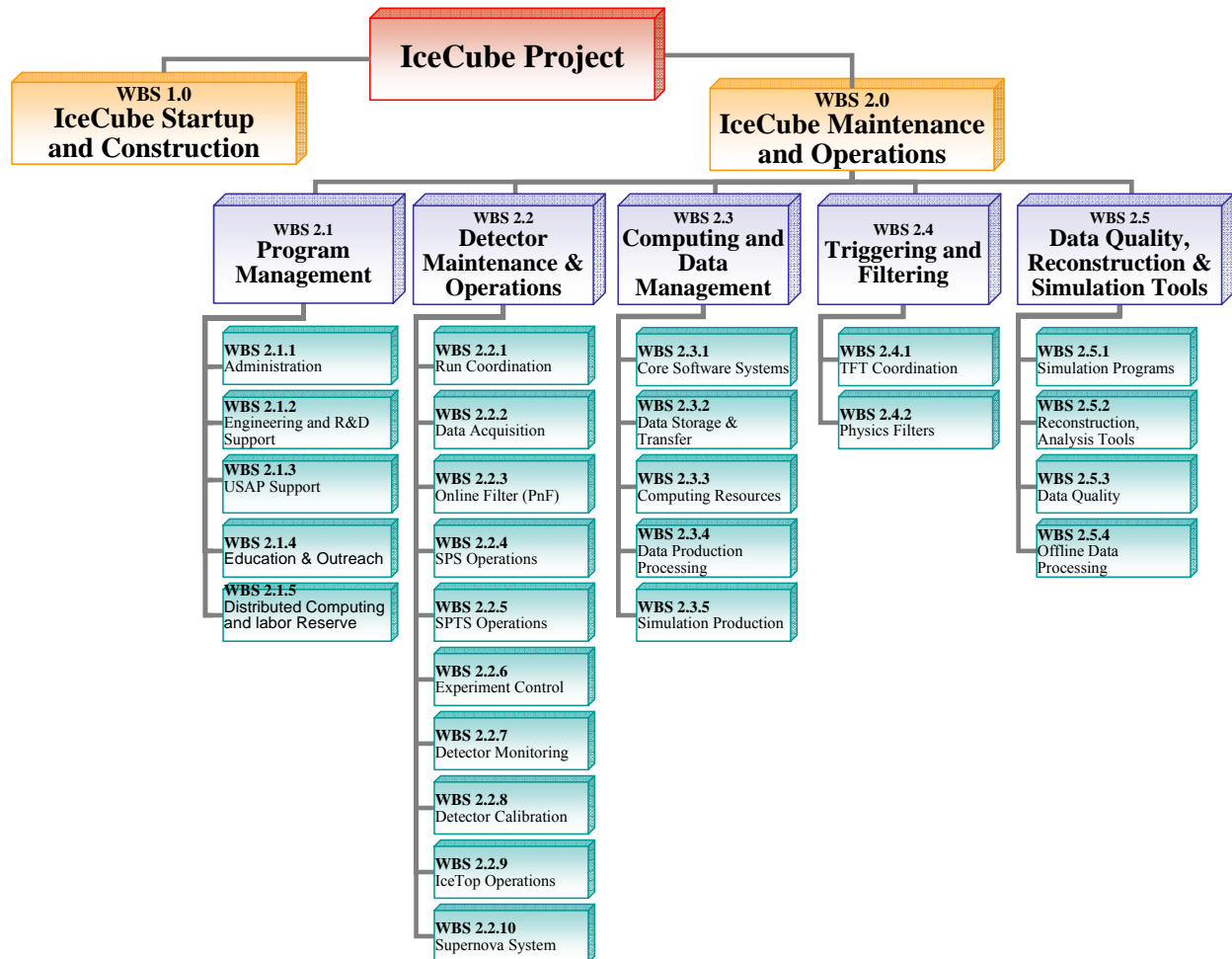



Appendix 2: IceCube M&O Memorandum of Understanding Effort and Authors Head Count Summary

v 9.0 , September 15, 2010		Authors Head Count				M&O Responsibilities funded by NSF M&O Core & Inst. In-Kind (FTE)					
Funding Agency	Institution (Lead)	Ph.D. scientists	Faculty	Scientists / Post Docs	PhD. Students	WBS 2.1 Program Management	WBS 2.2 Detector Operations & Maintenance	WBS 2.3 Computing & Data Management	WBS 2.4 Triggering & Filtering	WBS 2.5 Data Quality, Reconstruction & Simulation Tools	Total
NSF	University of Alabama (Dawn Williams)	3	(2	1	2)	0.75	0.63			0.45	1.83
NSF	University of Alaska (Katherine Rawlins)	1	(1	0	0)		0.02			0.30	0.32
NSF	Clark Atlanta (George Japaridze)	1	(1	0	0)		0.02				0.02
NSF	Georgia Tech (Ignacio Taboada)	2	(1	1	1)	0.25	0.23	0.20	0.00		0.68
NSF	LBNL (Spencer Klein)	7	(3	4	1)	0.15	0.89	0.20	0.25	0.80	2.29
NSF	Ohio State University (James Beatty)	3	(1	2	1)	0.05	0.23		0.15	0.10	0.53
NSF	Pennsylvania State University (Doug Cowen)	5	(3	2	2)	0.30	0.06	0.42	0.68	0.33	1.78
NSF	Southern University (Ali Fazely)	4	(3	1	0)		0.02	0.30		0.60	0.92
NSF	University of California, Berkeley (Buford Price)	3	(1	2	1)	0.20	0.78		0.25	0.50	1.73
NSF	University of California, Irvine (Steve Barwick)	2	(1	1	1)		0.02				0.02
NSF	University of Delaware (Paul Evenson, acting for T. Gaisser)	8	(4	4	2)	0.30	1.30	0.15	0.10	1.15	3.00
NSF	University of Kansas (Dave Besson)	1	(1	0	0)	0.10	0.02				0.12
NSF	University of Maryland (Greg Sullivan)	7	(4	3	6)	0.70	0.54	1.00	1.00	1.40	4.64
NSF	University of Wisconsin, River Falls (Jim Madsen)	3	(2	1	0)	0.25	0.05			0.30	0.60
NSF	University of Wisconsin, Madison (Albrecht Karle)	18	(5	13	12)	1.38	2.22	1.45	0.95	2.35	8.35
	U.S. Institutions Subtotal	68	(33	35	29)	4.43	7.02	3.72	3.38	8.28	26.82
DESY	DESY-Zeuthen (Christian Spiering)	8	(6	2	6)	0.25	0.83	2.75	0.20	0.30	4.33
BMBF	RWTH Aachen (Christopher Wiebusch)	3	(1	2	11)	0.20	0.09	1.45	0.40	0.95	3.09
BMBF	Universität Dortmund (Wolfgang Rhode)	1	(1	0	4)		0.03	0.65		0.20	0.88
BMBF	Universität Mainz (Lutz Köpke)	1	(1	0	7)	0.15	1.00	0.45		0.20	1.80
BMBF	Universität Wuppertal (Klaus Helbing)	3	(2	1	7)	0.40	0.60	0.40	0.20	0.50	2.10
BMBF	Humboldt Universität Berlin (Hermann Kolanoski)	2	(1	1	0)	0.00	0.13		0.40	0.10	0.63
BMBF	Universität Bochum (Julia Becker)	1	(1	0	1)	0.10	0.03			0.25	0.38
DFG	MPI Heidelberg (Elisa Resconi)	2	(1	1	3)	0.50	0.05			0.60	1.15
DFG	Universität Bonn (Marek Kowalski)	2	(1	1	2)	0.10	0.53		0.55	0.40	1.58
FNRS	Université Libre de Bruxelles (Daniel Bertrand)	4	(2	2	3)	0.30	0.23	0.50	0.20		1.23
FNRS	Université de Mons (Evelyne Daubie)	0	(0	0	1)		0.03	0.30			0.33
FWO	University of Gent (Dirk Ryckbosch)	3	(1	2	4)	0.10	0.03			0.50	0.63
FWO	Vrije Universiteit Brussel (Catherine de Clercq)	6	(2	4	1)		0.06	0.25	0.50	1.75	2.56
SRC	Stockholm University (Per Olof Hulth)	6	(4	2	2)	0.60	0.06	0.70	0.80	0.55	2.71
SRC	Uppsala University (Olga Botner)	4	(3	1	3)	0.70	0.23		0.60	0.05	1.58
NSERC	University of Alberta (Darren, Grant)	2	(1	1	0)			0.10	0.00	0.40	0.50
	University of the West Indies, Barbados (Suruj Seunarine)	1	(1	0	0)				0.15	0.15	0.30
STFC	University of Oxford (Subir Sarkar)	1	(1	0	0)		0.02			0.10	0.12
MARSDEN	University of Canterbury (Jenni Adams)	2	(1	1	3)		0.12			0.50	0.62
JSPS	Chiba University (Shigeru Yoshida)	3	(1	2	3)		0.03		0.40	0.60	1.03
SNSF	Ecole Polytechnique Federale de Lausanne (Mathieu Ribordy)	2	(1	1	2)	0.10	0.03			0.25	0.38
	Non-U.S. Institutions Subtotal	57	(33	24	63)	3.50	4.13	7.55	4.40	8.35	27.93
	Total U.S. & Non-U.S.	125	(66	59	92)	7.93	11.14	11.27	7.78	16.63	54.74

Changes since last official version of the MoU-SOW v8.3 are colored red



Appendix 3: IceCube Collaboration Governance Document

Revision 6.4
February 23, 2011

IceCube Collaboration Governance Document

Revision 6.4, February 23, 2011

Collaboration Objectives

The IceCube Collaboration (the Collaboration) is an organization of scientists who collectively participate in a research program with the IceCube Observatory at the NSF South Pole Amundsen-Scott station. IceCube consists of a surface array, IceTop, and a deep ice array IceCube. Henceforth, IceCube stands for the IceCube Observatory. The primary goal is the study of high-energy neutrinos from cosmic sources, but the program also encompasses a broader array of topics made possible by the IceCube observatory.

Definitions

The Host Institution for the IceCube project is the University of Wisconsin-Madison (UW) with the P.I. defined by the M&O grant to the Host Institution. Responsibilities are defined in the Cooperative Agreement with NSF. The Operations Phase of IceCube is specified as the period when activities are governed by the M&O Cooperative Agreement between UW and the NSF. The Memorandum of Understanding (MoU) governing institutional responsibilities for M&O consists of a single MOU between the host institution and all constituent institutions. The International Oversight and Finance Group functions are defined in the Maintenance and Operations Plan (excerpt attached in Appendix D). The organization for the operation of IceCube is shown in the organization chart of Appendix C.

Operation of the IceCube detector is organized within the IceCube Coordination Committee (ICC) chaired by the Associate Director for Science and Instrumentation. The main functions are Detector Maintenance & Operations; Computing and Data Management; Triggering & Filtering; and Data Quality, Simulation & Reconstruction Tools, as shown in the Organization chart. Some key positions in the ICC are appointments of the host institution; most positions are filled by collaboration scientists chosen for their expertise by the Chair of the ICC in consultation with the Spokesperson.

Collaboration Membership

The IceCube Collaboration consists of scientists at Collaboration Constituent Institutions. The condition for membership and for institutional recognition is that the group makes a significant contribution to IceCube. Significant contributions will include a contribution to the common fund proportional to the number of Ph.D. scientists in the group as well as contributions to detector operations and data analysis. The proposed contributions, role in the scientific program, and personnel are to be detailed in the MOU that is updated annually.

Current members of the Collaboration as of the date of revision of this document come from the institutions listed in Appendix A. (This Appendix also lists the initial institutions of IceCube.) Any scientist or group of scientists may apply to the Spokesperson of the Collaboration for membership of their institution in IceCube. Admission of new Collaboration Constituent Institutions requires approval by a two-thirds majority of the IceCube Collaboration Board of the proposed contributions, role in the research program, and terms of the initial MOU. Scientists who join member groups at Institutions that already are members of the Collaboration will automatically be accepted as members of the Collaboration.

An individual scientist or a group of scientists may be accepted as associate members of IceCube if they are sponsored by an IceCube collaborating institution to work on a specific aspect of analysis and/or service. The arrangement should be clarified in an MoU that describes the subject in which the associate will participate, the term of association and any other details.

Membership of an individual or Institution may be revoked by the Spokesperson for just cause, e.g. actions detrimental to IceCube. A two-thirds majority concurring vote is required of the Collaboration Board.

Collaboration Board

1. Functions and Responsibilities

The Collaboration Board is the policy-making entity that guides and governs the scientific activities of the Collaboration. It establishes, and as necessary amends, governance procedures and has oversight and authority over:

- science policy and goals
- membership
- data access
- publication
- representation of IceCube at topical and general conferences
- analysis teams
- education and outreach

The Collaboration Board, through the Collaboration Spokesperson, maintains contact and communication with the Director of Operations at the host institution.

It advises the Director on the detector operation for scientific investigations and maintenance, and participates in the discussion, as articulated by the Director of Operations, of the potential or possible use of the IceCube facility as a resource for new initiatives.

The Collaboration Board ratifies the Collaboration Governance document and may introduce amendments to it.

The Collaboration Board ratifies the Cooperative agreement between the NSF and Host Institution, and may suggest amendments to it.

The Collaboration Board, during the operation phase of IceCube, advises the Director of Operations on selection of personnel that hold key responsibilities for the Maintenance and Operation of the detector.

Concerns of the Collaboration members are addressed to Collaboration Board members who, when appropriate, bring those before the Collaboration Board for its consideration.

At the request of a Board member the Board may require a detailed verbal, or written, report from the Spokesperson on any action.

2. Membership

Each Collaboration Constituent Institution is represented on the Collaboration Boards by at most two members of which one is voting whereas the other is a non-voting adjunct member. The number of votes per institution depends on number of Ph.D. physicists (see for the key section 6 below).

Early Career - less than five years after the Ph D - scientists in the Collaboration are represented by two additional, at-large, members chosen collectively by Early-Career Collaboration participants. The term of service is one year, renewable. Election rules for Early Career scientists are given in Appendix B. Of the two members, one is voting whereas the other is a non-voting adjunct member. Information of who is voting should be given to the Spokesperson before each meeting of the Collaboration Board. During the IceCube operation phase, the P.I. of the M&O grant from NSF (the IceCube P.I.) and the Associate Director for Science are ex-officio members of the Collaboration Board.

3. Officers

The Collaboration Board is chaired by the Collaboration Spokesperson. The Spokesperson is an ex-officio, non-voting member of the Collaboration Board. The Spokesperson is elected by the Ph.D. members of the collaboration. The election procedure is as follows:

- The Spokesperson appoints two Collaboration members who serve as a nomination commission.
- Nominations are sought from the Collaboration at large. Each constituent Institution may offer any number of candidate nominees
- The nomination commission notifies each nominee that she/he has been proposed. Within two weeks each nominee shall inform the nomination commission if he/she is willing to be listed as a nominee. All who do so compose the final slate of viable nominees.
- The Spokesperson is chosen by majority vote of all Ph.D. physicists in the Collaboration.
- If none of the candidates gets more than 50% of the votes in the first round the choice between the two names with the most votes is decided in a second round.

Each nominee is urged to prepare a statement that contains her/his assessment of the state of IceCube, goals and plans for action to be taken during his/her tenure as Spokesperson. The text of the statement should accompany the nominee's acceptance notice to the nomination commission who will distribute it with the ballot to the Collaboration membership.

The Spokesperson may select a Deputy Spokesperson. The Board ratifies the choice. The Deputy performs the duties of the Spokesperson when necessary if the Spokesperson is unable to do so. The Deputy is an ex-officio, non-voting member of the Collaboration Board. If the Spokesperson or Deputy is a regular Collaboration Board member, a replacement is chosen by the affected Institution. The period of office of the Spokesperson and the Deputy Spokesperson is two years, renewable - but at most four consecutive years.

The Spokesperson, as Collaboration Executive

- organizes and chairs Collaboration Board meetings
- during the IceCube operations phase is the interface between the collaboration Board and the Director of Operations at the Host Institution, communicating with the Director on behalf of the Collaboration Board.
- arranges general Collaboration meetings
- speaks for the Collaboration in interaction with the scientific community
- speaks for the Collaboration in interaction with the general public
- selects members of Collaboration advisory committees subject to concurrence by Collaboration Board majority vote
- communicates with the International Oversight and Finance Group (see Appendix D) on behalf of the Collaboration Board.
- calls for and oversees formal votes on particular issues

4. Executive Committee

The Spokesperson, in consultation with the Collaboration Board and, with the P.I. and the Director of Operations, appoints and chairs an Executive Committee of the Collaboration Board. The term of the Executive members is two years. The job of the Executive Committee is to advise the Spokesperson in proposing actions to the Collaboration Board and in making interim decisions. The members of the Executive Committee should represent major groups, functions and competences within the Collaboration.

5. Meetings

As a rule, the Collaboration Board meets during general Collaboration meetings. More frequent telephone or video conferences may be called by the Spokesperson, with normally two weeks prior notice having been given Board members. A minimum of two-thirds of Collaboration Board members is required to constitute a quorum. The Spokesperson will appoint a secretary to each Collaboration Meeting for writing the minutes. The minutes will include all decisions that were taken. Minutes will be posted on the IceCube private www site within one week following the meeting, following approval by the Collaboration Board members.

6. Voting procedure

In general, matters before the Collaboration Board are settled by consensus of its members. A formal vote will be ordered by the Spokesperson, if called for by a Collaboration Board member or by the Spokesperson. Each institution has one vote weighted by a factor depending on the number of affiliated PhD physicists. The weight is equal to the square root of the number of PhD physicists, rounded to the nearest integer. The weights are fixed once per year. In case of a tie vote, the Spokesperson casts a vote. Results will be announced to the Collaboration Board by the Spokesperson. Polling is done by Email or at meetings of the Collaboration Board. All votes will be open, except where persons are concerned. The voting procedure for the Spokesperson is described in section 3.

7. Education and Outreach

The IceCube collaboration collectively and individually participates in and provides support for efforts in public outreach and education on subjects related to its science. The Spokesperson, with Collaboration Board concurrence, responds to requests for information from the media or may take the initiative providing material. The Director of Operations, with Collaboration Board concurrence, appoints a Collaboration member to lead an education program for students and teachers at all levels. The Collaboration maintains coordination and cooperation with other ongoing education initiatives. All new scientific material to be released for purposes of public outreach or education containing other than previously published data or results must have been agreed upon by the Collaboration Board.

8. Collaboration Policies and Procedures

Meetings

Collaboration meetings are held at least two times in a year. Locations are distributed among Collaboration Constituent institutions, chosen by the Spokesperson, and ratified by Board concurrence. The hosting institution is responsible for physical meeting arrangements. Agendas are set by the Spokesperson together with the hosting institution, the Analysis Coordinator, the working group leads and the operations managers (i.e. members of the ICC), with concurrence of the Collaboration Board.

Data Reduction and Analysis

Raw, unfiltered data written to tape at Pole are transported to the UW data center for archival storage unless directed otherwise by the Collaboration Board. Filtered data are transmitted daily via satellite link to the UW data center and stored on disk. Additionally, the filtered data will be copied via internet to DESY and stored on disk as a second official copy.

All current IceCube members have access to archived data. Associate membership in IceCube gives the Associate access to IceCube data and software

for the sole purpose of pursuing a particular analysis. The analysis should augment the science that can be done with IceCube alone.

The Collaboration Board consents to the appointment of Collaboration members who have been chosen jointly by the Spokesperson and Director of Operations. These include the Analysis Coordinator and Working Group conveners. The term of service for the Analysis Coordinator and Working Group conveners is two years, renewable. The Analysis Coordinator assumes responsibility for organization and management of data analysis efforts.

It is the intention of the Collaboration to place the data in the public domain as soon as it is reasonable to do so from a scientific point of view (see appendix E). The Collaboration Board shall determine rules for access to the data.

Detector operations and monitoring

The Spokesperson with Collaboration Board concurrence appoints a Collaboration member to organize and lead a group responsible for detector Monitoring, Maintenance and Calibration. The term of service is one year, renewable. Detector monitoring is a collaboration-wide shared responsibility.

9. Topical and General Conference Presentations

The Spokesperson, with concurrence of the Collaboration Board, appoints a Collaboration member to chair a Speakers Committee. The designated chairperson chooses three other members of this Speakers Committee. The term of the speakers committee is 2 years. A rapid decision channel (chair + Spokesperson) can be enabled if there is insufficient time to involve the whole committee. Invitations to present Collaboration results, or performance reviews, are submitted to the Speakers Committee. The Speakers Committee chooses the speaker.

The Speakers Committee maintains records of conference presentations. The conference organization is notified by the Spokesperson of the identity of the nominated speaker and the subject of the talk and its approval is sought.

In order to present previously unreported data and/or results approval must be obtained from the Spokesperson, with Collaboration Board concurrence. The Spokesperson has the right to hold new results in order to approve final text, figures, and tables.

Transcriptions of verbatim reports of approved presentations to be included in conference proceedings are posted on the IceCube www site not later than two weeks before the editorial deadline to allow review, comments and suggestions for revisions by the Collaboration. Such controls do not normally apply to colloquium or seminar talks at members' home or other institutions on personal invitation but the Analysis Coordinator must be made aware of any new results which differ from results already public or might be controversial. For presenting such results Analysis Coordinator approval must be obtained.

Reports in proceedings are normally bylined by a single name (the presenter's) followed by "for the IceCube Collaboration". The complete author list in alphabetic order should if possible be included. Otherwise a reference is made to the complete author list elsewhere. Deviations from this rule are possible on a case by case basis but require justification. Requests are handled by the Publication Committee. The Collaboration Board constructs the author list from compilations provided it by Constituent Institution representatives. Others who have contributed to a particular effort may be included as authors. Individual requests not to be included as authors are acceded to without prejudice.

Any Constituent Institution representative may request a variance from the default listing to allow a conference presentation authored by a subset of members and others who have contributed to a particular special (usually technical) subject. A 2/3 majority of the Collaboration Board is required for approval.

10. Publications

The Spokesperson, with concurrence of the Collaboration Board, appoints a Collaboration member to chair a Publications Committee. The designated chairperson chooses seven other members of this Publications Committee. The term of the members of the Publication Committee is 2 years, renewable. The committee oversees and coordinates submission of papers and proceedings reports in coordination with the analysis coordinator and the working group leaders as described in Appendix C.

Results are to be submitted for publication in refereed journals. Drafts of research results are prepared by the analysis teams; drafts of papers on technical matters are prepared by the cognizant individuals. The internal review procedure is described in Appendix C. Journal articles are bylined by the full author list in alphabetical order. The Collaboration Board constructs the author list from compilations provided it by Constituent Institution representatives. As a rule collaborators may become authors six months after joining the collaboration. They are normally removed from the list one year after leaving. This period may be extended in special cases of former collaborators who contributed essential effort to the construction of IceCube. Others who have contributed to a particular effort may be included as authors. Individual requests not to be included as authors are acceded to without prejudice. Any Constituent Institution representative may request a variance from the default listing to allow submission of a paper for publication authored by a subset of members and others who have contributed to a particular special (usually technical) subject. A 2/3 majority of the Collaboration Board is required for approval.

Associate members only appear on the author list for the publication(s) directly related to their analysis and agree not to publish independently results based on private IceCube software or data.

11. Ph D Research

Research topic assignments are the responsibility of the students and faculty supervisors. Discussions among faculty supervisors and Collaboration Board members are encouraged to avoid serious overlaps in subject matter and/or analysis methodology. The Spokesperson maintains a list of completed and current theses. Texts of theses are posted to the IceCube private www site and may be posted at the institution www site. Titles and author names are posted on the official IceCube www site.

12. Amendments

This document will be reviewed for proposed amendments as necessary. Any member of the collaboration may bring such proposals to the Collaboration Board's attention. Proposed amendments to this charter will be considered during regular meetings of the Collaboration Board. A 2/3 majority of the Collaboration Board is necessary to pass an amendment.

Appendix A: IceCube Institutions

(ordered alphabetically according to location)

a. Initial IceCube Institutions (application 1999 to NSF):

- i. CTSPS, Clark-Atlanta University, Atlanta, USA
- ii. Southern University and A&M College, Baton Rouge, USA
- iii. Lawrence Berkeley National Laboratory, Berkeley, USA
- iv. University of California-Berkeley, Berkeley, USA
- v. Université Libre de Bruxelles, Brussels, Belgium
- vi. University of California-Irvine, Irvine, USA
- vii. University of Kansas, Lawrence, USA
- viii. University of Wisconsin, Madison, USA
- ix. Universität Mainz, Mainz, Germany
- x. Bartol Research Institute, University of Delaware, Newark, USA
- xi. University of Pennsylvania, Philadelphia, USA
- xii. Institute for Advanced Studies, Princeton, USA
- xiii. Stockholm Universitet, Stockholm, Sweden
- xiv. Uppsala Universitet, Uppsala, Sweden
- xv. BUGH Wuppertal, Wuppertal, Germany
- xvi. DESY-Zeuthen, Zeuthen, Germany

b. IceCube Institutions as of September, 2010:

- i. III. Physikalisches Institut, RWTH Aachen University, Aachen, Germany
- ii. Dept. of Physics and Astronomy, University of Alabama, Tuscaloosa, USA
- iii. Dept. of Physics and Astronomy, University of Alaska Anchorage, Anchorage, USA
- iv. CTSPS, Clark-Atlanta University, Atlanta, USA
- v. School of Physics and Center for Relativistic Astrophysics, Georgia Institute of Technology, Atlanta, USA
- vi. Dept. of Physics, Southern University, Baton Rouge, USA
- vii. Dept. of Physics, University of California, Berkeley, USA
- viii. Lawrence Berkeley National Laboratory, Berkeley, USA
- ix. Institut für Physik, Humboldt-Universität zu Berlin, Berlin, Germany
- x. Fakultät für Physik & Astronomie, Ruhr-Universität Bochum, Bochum, Germany
- xi. Physikalisches Institut, Universität Bonn, Bonn, Germany
- xii. Dept. of Physics, University of the West Indies, Bridgetown, Barbados
- xiii. Université Libre de Bruxelles, Brussels, Belgium
- xiv. Vrije Universiteit Brussel, Brussels, Belgium
- xv. Dept. of Physics, Chiba University, Chiba, Japan
- xvi. Dept. of Physics and Astronomy, University of Canterbury, Christchurch, New Zealand
- xvii. Dept. of Physics, University of Maryland, USA
- xviii. Dept. of Physics and Center for Cosmology and Astro-Particle Physics, Ohio State University, Columbus, USA
- xix. Dept. of Physics, TU Dortmund University, Dortmund, Germany

- xx. Dept. of Physics, University of Alberta, Edmonton, Alberta, Canada
- xxi. Dept. of Subatomic and Radiation Physics, University of Gent, Gent, Belgium
- xxii. Max-Planck-Institut für Kernphysik, Heidelberg, Germany
- xxiii. Dept. of Physics and Astronomy, University of California, Irvine, USA
- xxiv. Laboratory for High Energy Physics, École Polytechnique Fédérale, Lausanne, Switzerland
- xxv. Dept. of Physics and Astronomy, University of Kansas, Lawrence, USA
- xxvi. Dept. of Physics, University of Wisconsin, Madison, USA
- xxvii. Institute of Physics, University of Mainz, Mainz, Germany
- xxviii. Université de Mons, Mons, Belgium
- xxix. Bartol Research Institute and Department of Physics and Astronomy, University of Delaware, Newark, USA
- xxx. Dept. of Physics, University of Oxford, Oxford, UK
- xxxi. Dept. of Physics, University of Wisconsin, River Falls, USA
- xxxii. Oskar Klein Centre and Dept. of Physics, Stockholm University, Stockholm, Sweden
- xxxiii. Dept. of Physics, Pennsylvania State University, University Park, USA
- xxxiv. Dept. of Physics and Astronomy, Uppsala University, Uppsala, Sweden
- xxxv. Dept. of Physics, University of Wuppertal, Wuppertal, Germany
- xxxvi. DESY, Zeuthen, Germany

Appendix B: IceCube Early Career Scientist Elections

- a. **Definition of IceCube EC Scientist:** An Early Career scientist is a member of the IceCube collaboration who has received their Ph. D. within 5 years of the most recent past January 1st, but who has not received a tenured position.
- b. **Election Oversight Committee:** The EC representatives will annually and prior to the elections appoint a committee of two members taken from the entire collaboration, excluding persons eligible and accepting nominations for EC representative in the upcoming election, to oversee the election.
- c. **Nominations for EC Representative:** The current year's representatives will solicit nominations collaboration-wide for EC representatives. These nominations will be collected by the members of the oversight committee and posted. Self-nomination is permitted.
- d. **Voting:** Each EC scientist possesses two votes. One vote is weighted with 2 points, the other is weighted with 1 point. Each vote must be assigned to a different person - i.e. a single vote caster may not vote all 3 points to a single nominee. These votes are sent to the oversight committee. One is allowed to vote for one's self. Votes are counted privately by the oversight committee. The two persons receiving the top two vote counts will be announced by this committee as the new EC scientist corepresentatives. In the event of a tie between 2nd and further places, a tie-breaking round of voting with the ballot containing just the tie holders, will be held to determine 2nd place, with a single vote per EC scientist.

Appendix C: IceCube Maintenance, Operations and Data Analysis Plan

This document sets forth the plan for the organization and implementation for M&O and Data Analysis during the operations phase of IceCube.

M&O and Physics Analysis

- Planning Documentation
- Analysis Coordination
- Internal review Process
- Talks

Planning Documentation

Planning documentation is composed of this document in its entirety, which lays out the plan for M&O and data analysis of IceCube data. This plan will be reviewed by the IceCube Director of Operations and the IceCube collaboration and once approved will be implemented. Approval and/or modification requires the data analysis plan to be accepted by:

1. IceCube PI
2. IceCube Collaboration Spokesperson
3. IceCube Director of Operations
4. IceCube Collaboration Board

This document should not conflict with the IceCube collaboration governance document. If there are any conflicts the collaboration governance document takes precedent.

Analysis Coordination

Analysis coordination has two tasks that are:

- Analysis Coordinator
- Working Groups

The analysis coordinator has authority over the working groups as laid out in this document.

Analysis Coordinator

- a) Selection of Analysis Coordinator

The procedure for selecting the Analysis Coordinator is by appointment from the Spokesperson with concurrence of the Collaboration Board.

b) Term of Analysis Coordinator

The term of the Analysis coordinator will be two years. The current Analysis Coordinator may be nominated to remain as Analysis Coordinator.

c) Responsibilities of Analysis Coordinator

The responsibilities of the analysis coordinator are the overall organization and oversight of the working groups and physics analysis of the IceCube data. Specifically the Analysis Coordinator will:

1. Have oversight of the physics analysis
2. Aid in defining the physics working groups
3. Aid in selection of working group leaders
4. Have input on internal review processes for publications and talks
5. Have input on the distribution of talks
6. Have oversight of analysis documentation

Working Groups

a) Preliminary list of working groups

Working groups are organized a) according to event topologies and the related filter and reconstruction methods and b) according to physics topics. Topology-driven groups can be, for instance:

1. Muons
2. Cascades
3. Hybrid events
4. ...

with the physics topics such as AGN, GRB, WIMPs etc... as subcategories in each working group with the same physics topic across groups. A possible grouping according to physics topics would be:

1. Diffuse cosmic and atmospheric neutrinos
2. Point Source Searches
3. GRB neutrinos
4. neutrinos from WIMP annihilation
5. Cosmic ray studies
6. Exotic particles like magnetic monopoles or Q-balls
7. MeV neutrinos from Supernova bursts
8. Extremely High Energy Phenomena (EHE)

with detector and reconstruction methods as tools to be developed across different working groups. Definition of groups will be kept dynamically, with the list above representing the 2010 status.

b) Selection of Working Groups & Group Leaders

The Analysis Coordinator will coordinate and implement the analysis effort for the IceCube detector in order for it to accomplish its scientific mission. The analysis coordinator, with input from the entire collaboration, will determine the physics benchmarks and processes and organize physics working groups to ensure that these processes are measured. The Analysis Coordinator together with the Spokesperson will select the working group leaders with input from the IceCube collaboration and IceCube Director of Operations. The term of office of a working group leader is 2 years, renewable.

c) Responsibilities at Working Group Level

The physics working group leaders have direct responsibility for organizing the individual data analyses of the IceCube detector. They will:

1. Organize their physics working group
2. Define & verify standard datasets for their particular physics processes
3. Verify the operation and performance of the IceCube detector, primarily as it pertains to their physics processes of interest
4. Document the physics analysis and approved results with memos
5. Document analysis tools with memos
6. Place memos on Docushare for collaboration access and maintain the Docushare areas related to their working group
7. In addition to memos on Docushare, maintain a (possibly separate) web page that describes the status of the WGs activities
8. Approve standard results from their group to be submitted to the collaboration board for publication and presentation.
9. Request a paper committee for journal publication of approved results

The people within a physics working group should generally be organized by the working group leader, with a mailing list established. However, all physics working group activity is open to the entire collaboration at any time. Regular meeting times and activities should be established whenever possible to encourage all who are interested to be able to plan on participation. The working groups are encouraged to schedule regular biweekly teleconferences and/or videoconferences.

Internal Review Process

Internal review is the process by which the IceCube collaboration will assure uniform and high standards for the publication and communication of physics results to the community. There are two levels of approval for results:

1. Approval as preliminary result for communication at conferences and talks
2. Approval of final results for publication in refereed journals

a) Approval of preliminary results for talks

For approval of preliminary results to be disseminated to the community at scientific talks and conferences the following must happen:

1. Approval by physics working group.
2. Presentation at two consecutive weekly analysis calls where approval is sought from the collaboration.
3. Decision by the Analysis Coordinator.

Normally, a memo with supporting information should be disseminated to the collaboration no less than two weeks before the Collaboration Board decision.

Upon approval, the result becomes an official preliminary result that is available for use in talks and conferences by any collaboration member. The result will be placed in a common collaboration area on the IceCube web pages by the physics working group.

b) Publication of papers

The publication of a result in a paper is initiated within a physics working group. The results to be published must be approved by the collaboration as described above. Once a draft exists, the working group leader(s) will contact the chair of the publication committee to jointly appoint a referee panel consisting of two working group internal experts and a collaboration member from outside the working group. The panel will be led by a publication committee member. The task of the referee panel will be to review the draft and see to it that any remaining physics issues are resolved. The referee panel oversees and approves the steps listed below leading to journal submission.

1. A first draft of the paper is sent to the collaboration. Two weeks are allowed for comments which should be mainly of a substantive nature, but can also be editorial. The paper, comments, and answers to comments should all be posted on the web.
2. When the referee panel is satisfied that questions and comments have been satisfactorily addressed, a second draft will be presented to the collaboration. These comments should be editorial in nature. The paper, comments, and answers to comments should all be posted on the web.

3. The referee panel decides when a final draft of the paper is presented to the collaboration for approval.
4. The publication committee considers the paper for submission. The decision to submit is made by the Spokesperson and the chair of the publication committee.

c) Unusual physics topics or topics of a general nature

In the event of an analysis that does not fall within a physics working group, the analysis coordinator will contact the chair of the publication committee to jointly appoint a referee panel.

A topic of a general nature or a physics topic which should be dealt with in publication but is not being addressed can be brought before the Collaboration Board by the Spokesperson, the chair of the publication committee and/or the analysis coordinator. The Collaboration Board appoints an individual (or individuals) responsible for producing a draft paper and if necessary for performing the analysis.

d) Circumstances requiring express analysis

If a case arises that would require an express analysis of IceCube data in order to increase the impact in a timely way (e.g. A strong flaring object such as occurred for the “naked-eye” GRB) the Analysis Coordinator and/or Spokesperson have the authority to circumvent the normal time periods for review. The Analysis coordinator and Spokesperson can at their discretion ask for concurrence from the executive committee and/or ICB.

Non-IceCube publications by IceCube members

Collaboration members co-authoring non-IceCube publications which at any level relate to IceCube (for instance relying on internal discussions within IceCube, using IceCube infrastructure (hardware or software), or relying heavily on published IceCube results) should notify the IceCube Publication Committee prior to the submission of any manuscript to archive or journal. The Publication Committee may decide to forward such information to the full collaboration.

Talks

The policy on talks and presentations, and on the speakers committee is set forth in section 9.

IceCube M&O Organization

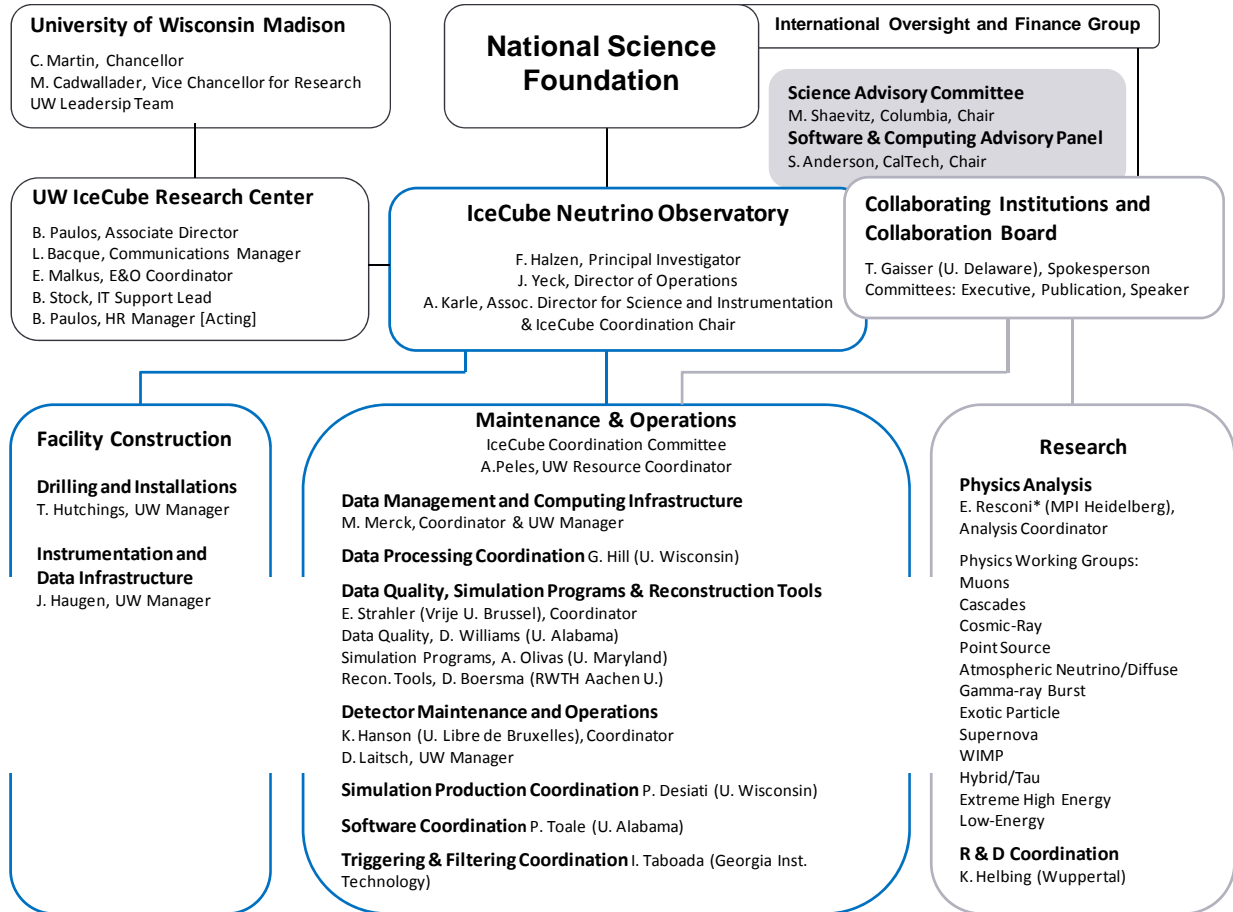

*Member of the IceCube Coordination Committee

February 9, 2011

Appendix D: International Oversight and Finance Group - IOFG

The International Oversight and Finance Group (IOFG) is a committee created in 2004 to provide oversight and financial support for the IceCube Neutrino Observatory (including Construction phase, Maintenance & Operations and Research phases). The Group organizes annual oversight reviews of the operations and meets annually to discuss detector performance and physics. The Group also sets policies for receiving periodic progress reports on all aspects of the detector operation and by all the performers in the collaboration, and for conducting external reviews when appropriate.

Membership

A representative of the National Science Foundation chairs the IOFG. Membership is comprised of representatives of the funding agencies in the partner countries supporting the construction and operation of IceCube Neutrino Observatory, currently comprised of funding agencies from Belgium, Germany, Sweden, and the United States. The Group is informed by the Spokesperson of the Collaboration, the Director of Operations, the Principal Investigator and others as appropriate.

Decisions

The Group is committed to operate through discussion and consensus. The Executive Agent (the NSF) will make final decisions on matters before the group related to the operation of IceCube.

Issues that may come before the Group include:

- Approval of a formal charter for the Group.
- Review of Memoranda of Understanding (MOU) between the various institutions.
- Concurrence on the Maintenance and Operations Plan.
- Funding issues.
- Concurrence on the Collaboration's plans for new membership in the collaboration.
- Data sharing and data management policies.
- Coordination regarding press releases and education and outreach activities.
- Input on seasonal flight and personnel logistics planning.
- Other matters related to successful operation of the IceCube Neutrino Observatory for science.

Appendix E: Dissemination and Sharing of IceCube Research Results and Data

This defines the IceCube strategy for providing access to research results and data by the broader research community. NSF policies and guidance promote efforts by grantees to produce the timely publication of results and to make data and software available to other researchers. In addition, the Parties to the Antarctic Treaty agree that, to the greatest extent feasible and practicable, scientific observations and results from Antarctica shall be exchanged and made freely available.

IceCube is a facility-class experiment with the primary goal to identify sources of astrophysical neutrinos. NSF supports a wide range of approaches to the release of facility data, e.g., the particle physics model where data is exclusively available to members of the collaboration and the astronomy model where data are readily made public.

The Large Hadron Collider experiments follow the particle physics model; the Atacama Large Millimeter/submillimeter Array (ALMA) the astronomy model; and, the Wilkinson Microwave Anisotropy Probe (WMAP) an intermediate model. IceCube is similar to WMAP and large air shower experiments where data is collected, analyzed, published and released.

The public release of data in a scientifically meaningful way is not a trivial undertaking. Currently there are three ways to access IceCube data:

- 1) IceCube Collaboration Membership
- 2) Associate Membership
- 3) Direct Access to IceCube Public Data Pages

IceCube Collaboration Membership – The IceCube Collaboration consists of scientists at Collaboration Constituent Institutions. The condition for membership and for institutional recognition is that the group makes a significant contribution to IceCube.

Any scientist or group of scientists may apply to the Spokesperson of the Collaboration for membership of their institution in IceCube. Details on these arrangements can be found elsewhere in this IceCube Collaboration Governance Document. New groups join the IceCube Collaboration every year providing evidence that membership is a proven way to access IceCube data.

Associate Membership – Scientists outside the IceCube Collaboration who have a concept for a particular analysis can apply to the Collaboration for Associate Membership for the purpose of performing a particular analysis or class of analyses within the Collaboration. Papers that cover the research in question are co-signed by the associate and the collaboration. The Associate Member has no other rights or responsibilities within IceCube. Associate Membership may be preferred over joining the Collaboration, a rather lengthy process that requires financial and service contributions operations.

There are a number of active Associate Members including the University of Tokyo and the South Dakota School of Mines and Technology.

Direct Access to IceCube Public Data Pages – Raw data is securely stored and backed up, consistent with NSF policy. Extracting science from the data requires the use of elaborate hardware and software tools developed by the Collaboration. Like any other particle physics detector, data directly relevant to a scientific issue are obtained after analysis chains that typically require the coordinated efforts of several members of the Collaboration.

In order to be responsive to both the scientific communities' need for usable scientific data and to the NSF requirement for public access to unselected data, IceCube plans to release data in two ways.

1. Release of event reconstruction information for events selected as neutrinos from the overwhelming background of cosmic ray muons.
2. Release of primary event data on all events transferred north over the satellite and used as the basis for analyses.

Data will be made available upon publication of results. For example, when the initial searches for point sources, neutrinos from transient sources, and diffuse astrophysical neutrinos are published the relevant event information associated with this analysis will be made available in an easy to read format. The event information will include reconstructed direction (right ascension, declination), time, reconstructed energy, and quality information of these events. Partial information may be made available earlier.

The IceCube Collaboration has created a data release webpage that serves as the entry point for future data releases to the scientific community, <http://www.icecube.wisc.edu/science/data>. Initially, this webpage contains release of the 2000-2006 AMANDA data. The URL to IceCube data release webpage is an explicit reference in the corresponding journal publication and will remain the same during IceCube operations (Abbasi et al. (IceCube Collaboration) Phys.Rev.D79:062001,2009. e-Print: arXiv:0809.1646). A second, similar, entry point will be developed and made available to the public for the release of "primary" data.

IceCube data releases will follow a similar procedure as the process used to release the AMANDA data. The first paper completed on the combined seven-year data set was the point source analysis. The initial release included right ascension and declination. A second update included identifiers for events included in a publication on atmospheric neutrinos and the Lorentz invariance. This sample is a subset of the full point source data set and meets the highest purity requirements. The final update to the data release page for AMANDA included the event times at full precision after a time dependent analysis on this event sample was completed.

During the operations phase of IceCube it is anticipated that IceCube neutrino data will be released within two to three years after the completed run in which the data are acquired. It is anticipated that the event information will consist of the reconstructed event information and quality information, including the likelihood that an event is caused by a neutrino. The event information might also include a measurement on the probability of the event being a muon or a cascade.

Important requirements for data release are: 1) the IceCube Collaboration's analyses are completed in accordance with the Collaboration's internal approval processes, which include adhering to the principles of blind analyses where practical, and, 2) the calibrations and reconstructed event information is high quality and it is unlikely the information will need to be changed or corrected.

Once IceCube is in steady state operation we continue to plan on annual cycles of data runs beginning in April. Data runs will consist of defined conditions of triggers, thresholds and operational conditions of the detector. The working groups analyze these data sets for the various physics analyses. A reasonable assumption is that ten to fifteen publications will be made using the annual data set and completed on a time scale of two years. Approximately two years after the annual data run is complete it is reasonable to expect that event information can be released. The data release cycle will follow the run completion cycle with a fixed time delay.

The sequence from data taking to publication can be summarized as follows:

1. Data Taking Run (~12 months)
2. Data Processing by Adding IceCube Event Reconstructions
3. Data Analyses for Specific Science Goals
2. Preparation of the Final Data Set
3. Perform Final Physics Analyses and Un-Blind Results
4. Publish Results
5. Release Data Set 1
6. Release Data Set 2

Data Release Set 1 – reconstructed events for the scientific community

The released data that is already reconstructed and most background events will have been removed from the final dataset published, will consist of the following quantities:

Event Time (MJD)
Direction (RA, Dec)
Directional Error
Degrees of Freedom in Fit
Energy Estimator
Flags to Indicate Event Type (e.g., track like, cascade like, etc.)

We plan to release these data in versions of event catalogs. We may revise a catalog of an earlier year to update information to include better reconstruction algorithms and filtering processes to offer a combinable set of data to the scientific community. Based on feedback from this community we may add more information in later releases to accommodate all types of community requests.

Data Release Set 2 – Public access of primary data

The release that contains all the primary detector data, which is calibrated, but not reconstructed, will consist of the following quantities:

Run/Event header with trigger information, event data and time, etc...

Array of all DOM signals with calibrated position, time, and charge (x,y,z,t,q)

We plan to release these events as yearly sets with the entire primary data in binary files on a time scale consistent with the release of data set 1. We will also supply on the website additional documentation to the public including a description of the binary data format, a general description of the detector quantities and what they represent, some illustrative event display pictures, links to relevant publications documenting the detector, and may possibly supply an event reader for a single platform and language. The anticipated size of one full year primary data is several to ten Terabytes, and may optionally require a small charge to cover the cost of physical media or internet server usage.



Appendix 4: IceCube Computing Infrastructure FY2010/2011 Upgrade Plan

The following list includes major FY2010/2011 IceCube computing infrastructure purchases for the South Pole System (SPS) upgrade, for the South Pole Test System (SPTS) upgrade and for the UW Data Warehouse and UW Data Center upgrades.

System upgrade	Item	Vendor	Line Items	Cost Category	Purchase amount
South Pole System (SPS) and	Servers	DELL	81 DELL R710 Servers	Cap. Equip.	\$438 K
			5 DELL R610 Servers	Cap. Equip.	\$25 K
			Service upgrade for DELL R610/R710 Servers	Service Agreements	\$79 K
			Spare parts for DELL servers	M&S	\$30 K
South Pole Test System (SPTS)	UPS	HP	2 HP R5500 XR UPS	Cap. Equip.	\$5 K
			2 HP R5500 XR UPS (spare)	M&S	\$7 K
			12 batteries for HP 5500XR UPS	M&S	\$9 K
	Disk Storage	HP	8 HP Storage Works LTO-4 Ultrium 1840 – SPS	Cap. Equip.	\$28 K
			2 HP Storage Works LTO-4 Ultrium 1840 - SPS (spare)	M&S	\$10 K
		DELL	70 146 GB SCSI 2.5inch Hard Drive	M&S	\$21 K
	Tape drives	MNJ	2 Quantum SUPERLOADER 3 LTO5 TAPE 1DR	Cap. Equip.	\$10 K
	Tapes Media	DELL	Tape Media for LTO4-120, 100 Pack	M&S	\$45 K
			Tape Media for LTO5 Cus 100 Pack	M&S	\$45 K
Rack Switches	Core BTS	Cisco 48-port rack switch to support SPTS buildup.	Cap. Equip.	\$13 K	
Data Warehouse Storage	Disk Storage	Storage IT solutions	AMS2500 dual controllers populated with 200 x 2 TB SATA drives	Cap. Equip.	\$263 K
			4 years hardware service	Service Agreements	\$45 K
			Software	M&S	\$6 K
			Software Service	Service Agreements	\$3 K
UW Data Center	Redhat	DLT Solutions	Renewal of Redhat Satellite Server and RedHat Enterprise Linux	M&S	\$18 K
	UPS	HP	4 HP R5500 XR UPS and Mgmt Cards	Cap. Equip.	\$10 K
		HP	27 Batteries for HP 5500XR UPS	M&S	\$21 K
Grand Total					\$1,130 K